



Supplies and Accessories Catalogue | Issue 11 2024

Providing High Quality ICP-OES & ICP-MS Sample Introduction Solutions for Over 40 Years.



Nebulizers

Introduction to Glass Expansion Nebulizers	1
Nebulizer Types.....	1
Glass Expansion Nebulizer Part Numbers Explained.....	1
Learn about Glass Expansion Nebulizers.....	2
Nebulizer Selection Guide	5

Spray Chambers

Introduction to Glass Expansion Spray Chambers.....	7
Spray Chamber Types.....	7
Helix CT - Interface Between Nebulizer and Spray Chamber.....	8
HydraMist Simultaneous Cold Vapor/Pneumatic Nebulization Spray Chamber	9
Spray Chamber Selection Guide.....	10

Torches

RF Coils

ICP-MS Cones

Accessories

IsoMist Programmable Temperature Spray Chambers.....	14
Guardian In-Line Sample Filter.....	15
Guardian In-Line Non-Return Gas Filter.....	15
Eluo Nebulizer Cleaning Tool.....	16
Elegra Argon Humidifier.....	16
High Efficiency Sample Introduction System for ICP-MS.....	17
Trident CT In-Line Reagent Additions Kit	18
Laser Ablation.....	19
Guardian Autosampler Probes	20
Autosampler Probes.....	21

Agilent Technologies®

7900.....ICP-MS.....	22
8900.....ICP-MS.....	25
7800/7850.....ICP-MS.....	28
7700/8800.....ICP-MS.....	31
5000 Series SVDV/VDV/RV.....ICP-OES.....	34

Analytik Jena®

PlasmaQuant 9000 Series.....ICP-OES.....	37
--	----

Nu Instruments®

Vitesse.....TOF-ICP-MS.....	39
-----------------------------	----

PerkinElmer®

NexION 2200.....ICP-MS.....	40
NexION 5000.....ICP-MS.....	42
NexION 1000, 1100, 2000.....ICP-MS.....	44
NexION 300/350.....ICP-MS.....	46
Avio 200/500 Series.....ICP-OES.....	49
Optima 8000/8300 DV.....ICP-OES.....	51

Shimadzu®

2040/2050.....ICP-MS.....	53
2030.....ICP-MS.....	55
9000/9800 and 7500/8100.....ICP-OES.....	58

Spectro™

Arcos II EOP/ Blue EOP/TI & Green TI.....ICP-OES.....	61
Arcos II SOP/ Blue SOP & Green SOP/DSOI...ICP-OES.....	64

Thermo Scientific™

MX Series.....ICP-MS.....	66
Q/RQ/TQ/RQ Plus.....ICP-MS.....	68
Neoma.....MC-ICP-MS.....	70
PRO Duo.....ICP-OES.....	72
PRO Radial.....ICP-OES.....	75
6000/7000 Duo.....ICP-OES.....	78
6000/7000 Radial.....ICP-OES.....	81

Fittings and Connectors

Nebulizer Fittings and Connectors.....	83
Spray Chamber/Torches Fittings and Connectors.....	85

Pump Tubing

Standard Peristaltic Pump Tubing.....	86
Contour Flared End Peristaltic Pump Tubing.....	87

Note: Clicking on the part numbers (PN) in this document will redirect you to our website for additional information.

Introduction to Glass Expansion Nebulizers

The nebulizer is a critical component of your ICP sample introduction system, so why not opt for the highest quality? Glass Expansion has been manufacturing ICP nebulizers since the early 1980s and continually updates nebulizer designs to improve performance and ease of use. Our proprietary designs include a thick walled VitriCone capillary, UniFit sample line connector and the Direct Connect (DC) product line.

Whether your ICP laboratory is analyzing clean aqueous samples, samples containing HF and/or high dissolved salts, or volatile organic solvents; Glass Expansion has a nebulizer to suit your needs. Learn about the performance advantages and overall difference in construction quality that a Glass Expansion nebulizer can provide your ICP laboratory.

Nebulizer Types

Nebulizer		TDS (%)	Particulates (µm)	HF	Precision	Purity	Material
SeaSpray™		20	75	No	High	Good	Glass
MicroMist™		15	40*	No	High	Good	Glass
Conikal™		5	75	No	High	Good	Glass
Slurry™		1	150	No	High	Good	Glass
Quartz SeaSpray™		20	75	No	High	Excellent	Quartz
OpalMist™		15	75*	Yes	High	Excellent	PFA
DuraMist™		30	75*	Yes	High	Good	PEEK
VeeSpray™		30	300	Yes	Moderate	Good	Ceramic

* Varies with nebulizer uptake

Understanding Nebulizer Part Numbers



Example: MicroMist DC Nebulizer
0.2mL/min



Prefix denoting the type of gas connector to suit ICP model
e.g. A13 = Agilent®

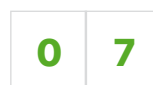

Argon flow in L/min
e.g. 07 = 0.7L/min
1 = 1L/min



Nebulizer model type
e.g. UM = MicroMist U-Series

- UC = Conikal U-Series
- US = Slurry U-Series
- UM = MicroMist U-Series
- CV = Ceramic Veespray V-Groove
- DM = DuraMist HF Resistant
- USS = SeaSpray U-Series
- PFA = OpalMist PFA HF Resistant



Aspirated uptake at nominal argon flow, in mL/min
e.g. 02 = 0.2mL/min
1 = 1mL/min

Learn About Glass Expansion Nebulizers

DC Nebulizers

The DC (Direct Connection) nebulizer has a UniFit sample connector which slides easily over the sample arm and an argon connector configured to connect directly to your ICP.

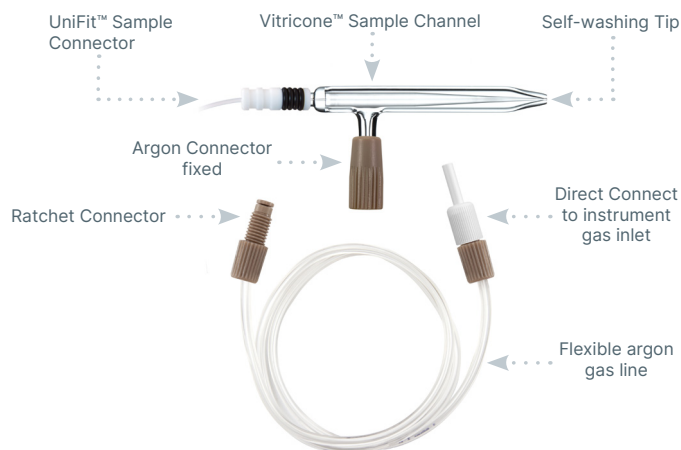

Benefits:

- Inert metal-free argon connector.
- Instrument-specific Direct Connect flexible argon line.
- Reliable ratchet fitting ensures leak-free gas connection.

DC versions of the SeaSpray, MicroMist, Conikal, Slurry, DuraMist, OpalMist and VeeSpray nebulizers are available to suit the most common models of ICP-OES and ICP-MS.

The DC nebulizer part number has a prefix specific to each type of gas connector. For example, the prefix "A13-" denotes a connector for the Agilent® 5000 ICP-OES Series, so part number A13-07-USS2 is a SeaSpray nebulizer configured for direct connection to the Agilent® 5000 Series.

In addition to these unique benefits, the DC nebulizer shares the following benefits with the U-Series nebulizer:

- **Resists blockage:** The sample channel is uniform from the entry point to the tip, so there is nowhere for particulates to be trapped.
- **Fast washout:** Since there is nowhere for sample to be trapped, the fastest possible washout and highest sample throughput is achieved.
- **Simple to use:** Our proprietary UniFit connector slides easily over the sample arm and creates an excellent seal.
- **Full length VitriCone construction:** With the VitriCone design, the sample channel is constructed from heavy glass capillary which is machined to very high tolerances.

Quartz SeaSpray DC Nebulizer

The Quartz SeaSpray DC nebulizer is made from ultra pure quartz and offers outstanding nebulization efficiency for trace level analyses. It offers freedom from clogging while nebulizing solutions to the limit of solubility of most mineral salts, and conferring significant sensitivity gains. It is specifically designed for ultra trace level analysis.



DC Nebulizer Gas Fitting Connectors

Manufacturer	Model	P/N Prefix	Gas Line Included	
Agilent Technologies®	4100/4200	MP11-	70-803-0969	
Agilent Technologies®	Vista/700-ES	A11-	70-803-0969	
Agilent Technologies®	7700/7800/7850/7900/8800/8900	A13-	70-803-1105	
Agilent Technologies®	5000 Series	A13-	70-803-1105	
Analytik Jena®	ICP-MS	A61-	70-803-2002	
Analytik Jena®	ICP-OES	A13-	70-803-1105	
Horiba® Jobin Yvon	All Models	A13-	70-803-1105	
Leeman	All Models	A11-	70-803-0969	
Nu Instruments	ICP-MS	A51-	70-803-1858	
Nu Instruments	TOF-ICP-MS	A52-	70-803-2044	
PerkinElmer®	ICP-OES	A21-	70-803-1070	
PerkinElmer®	Elan/NexION 300/350	A22-	70-803-1049	
PerkinElmer®	NexION 1000, 1100, 2000, 2200, 5000	A23-	70-803-1449	
Radom	MICAP® – OES™ 1000	A70-	70-803-2054	
Shimadzu®	All Models	A41-	70-803-1311	
Spectro™	All Models	A21-	70-803-1070	
Standard BioTools™ (Fluidigm)	Helios	A21-	70-803-1070	
Thermo Scientific™	PRO, 6000/7000, Q/RQ/TQ/RQ Plus, X-Series & Neoma	A31-	70-803-1105	
Thermo Scientific™	Neptune	A11-	70-803-0969	

U-Series Glass Concentric Nebulizers

SeaSpray, MicroMist, Conikal and Slurry U-Series nebulizers are available to suit all common models of ICP-OES and ICP-MS. Each U-Series nebulizer is supplied with a UniFit sample connector.

U-Series nebulizers can be identified by the letter 'U' in the part number, eg. ARG-07-USS2 or ARG-1-UM04.

The difference between the U series nebulizer and DC nebulizers lies solely in the argon gas connector. The U series nebulizer features the EzyLok argon connector, while DC nebulizers utilize advanced direct connect (DC) argon fittings. The inert, metal-free DC argon gas fittings and Ratchet Connector ensure reliable, reproducible, and leak-free connections, keeping analyses contaminant-free.



Nexus™ Universal Nebulizer Connection Kit

The Nexus™ Universal Connection Kit is a one-size-fits-all nebulizer connection kit which enables you to use any of Glass Expansion's industry-leading concentric nebulizers* with the sample introduction configuration of your choice, including switching valves, chromatographs (LC, HPLC, IC, etc.), and other high-performance accessories:

- **Switching Valves:** Simple and reliable custom-length connections to all high-throughput valve or syringe-drive systems.
- **Speciation Analysis:** Zero-dead-volume and secure, high-pressure connection for hyphenated techniques, such as LC-ICP-MS, HPLC-ICP-MS, IC-ICP-MS, and FFF-ICP-MS.
- **High-Efficiency Sample Introduction System (HE-SIS):** Connect to Glass Expansion's HE-SIS, which provides up to 95% transport efficiency for a variety of applications.
- **High-Precision Analysis:** Create a high-pressure seal when performing self-aspiration for the most stable sample uptake and delivery.

These easy-to-install kits are completely inert and configured for 1.6 mm (1/16") OD tubing, with PTFE ferrules that reliably seal with all commonly used capillary tubing materials, such as PFA, PTFE, FEP and PEEK. They provide a secure, zero-dead-volume direct connection to the liquid interface of a Glass Expansion nebulizer.

Nexus™ Universal Nebulizer Connection Kits

Nexus™ Universal Connection Kit for all Glass Concentric U-Series or DC nebulizers	FT-16-8
Nexus™ Universal Connection Kit for Inert nebulizers	FT-16-8-X
Nebulizer Sample Connecting Line Kit (0.18mm ID x 220mm)	70-803-2112
Connector Tube with 1/4-28 fitting 0.25mm ID x 700mm (PKT. 3)	70-803-1870
Connector Tube with 1/4-28 fitting 0.50mm ID x 700mm (PKT. 3)	70-803-1871
Replacement Flangeless Tefzel Ferrule 1.6mm for FT-16-8 and FT-16-8-X (PKT 10)	70-803-1315
Replacement Flangeless Tefzel Ferrule 1/8 inch for FT-16-8 (PKT 10)	70-803-1316
Replacement Flangeless Tefzel Ferrule 1/8 inch for FT-16-8-X (PKT 10)	70-803-1513

P/N FT-16-8

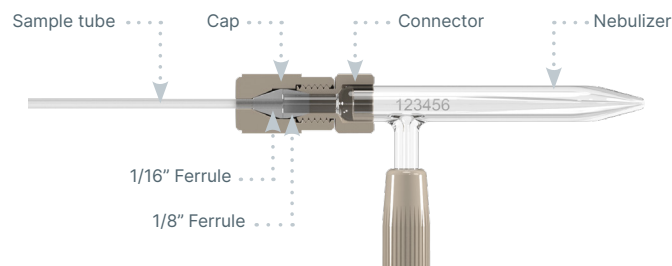

P/N FT-16-8-X

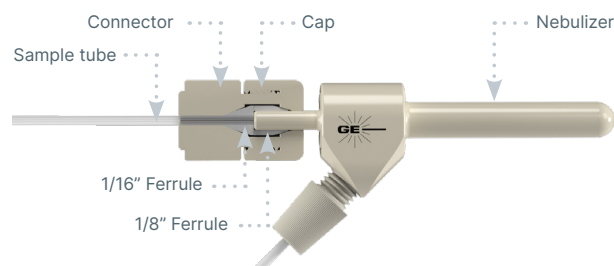

*The Nexus™ Universal Connection Kit is designed for U-Series (ARG) and DC (A##) nebulizers. It is not compatible with the older EzyFit (AR##) nebulizers.

Nebulizer Selection Guide

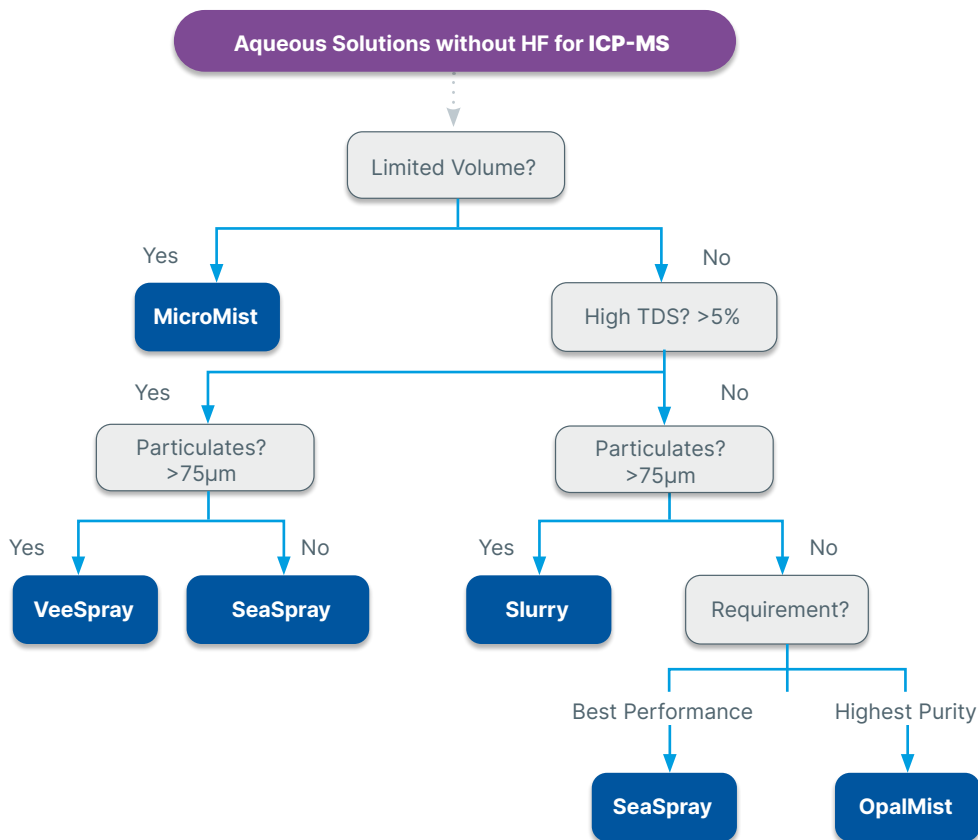
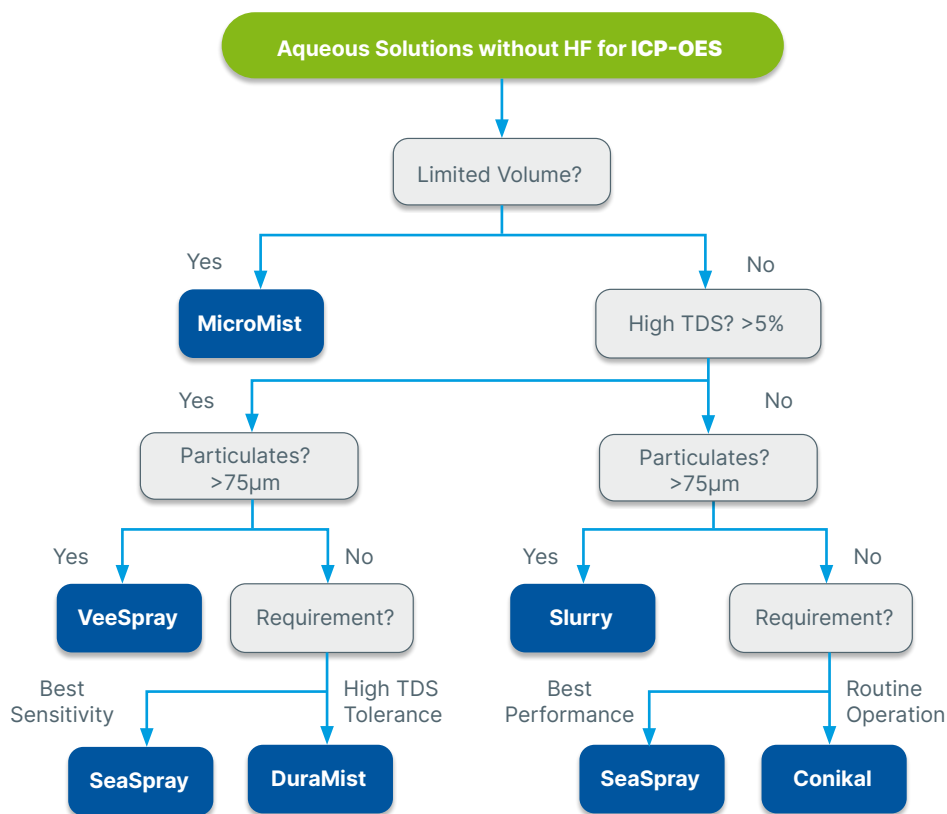

Nebulizer Selection Guide

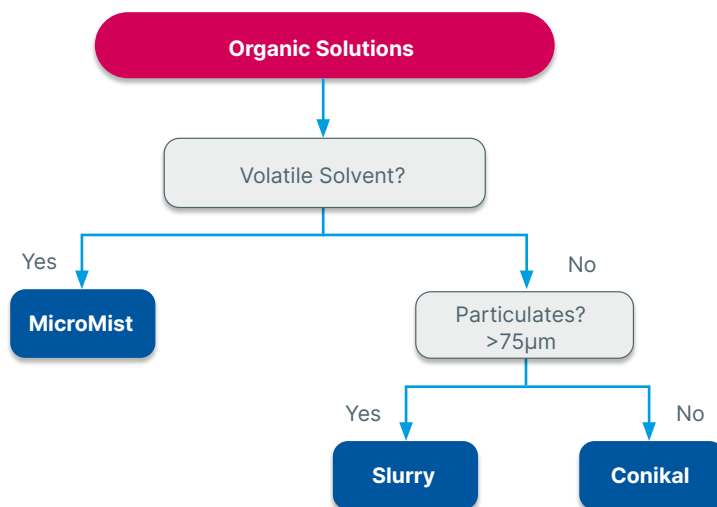
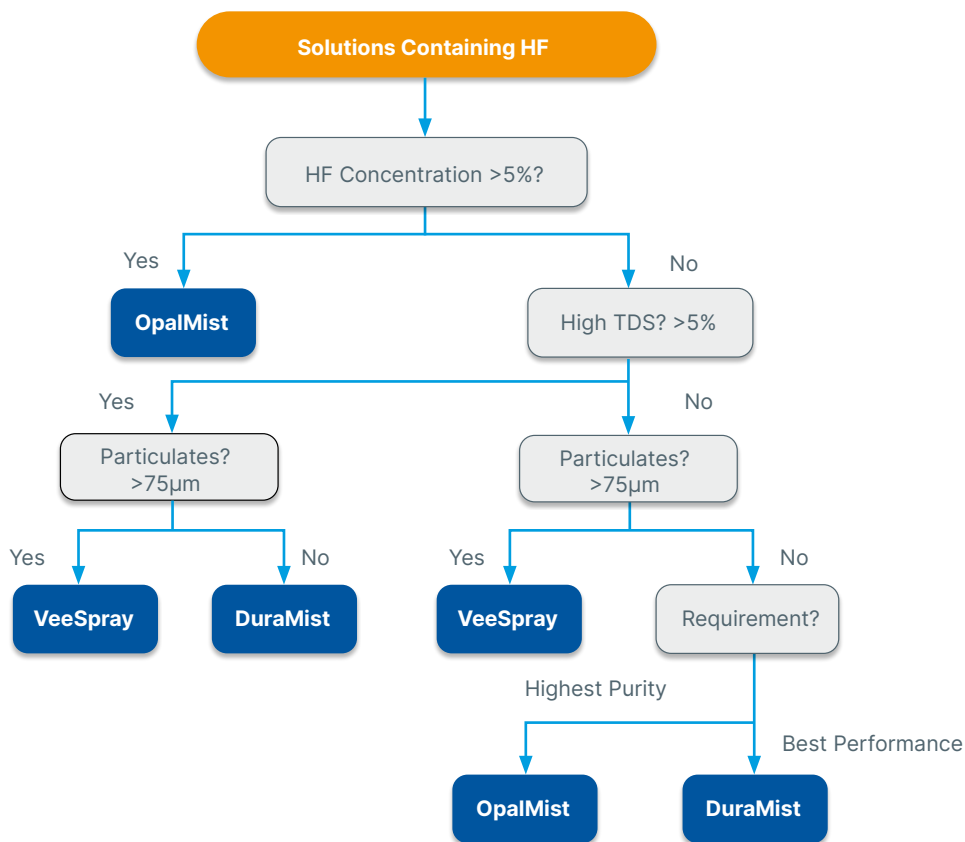

Introduction to Glass Expansion Spray Chambers

The spray chamber is a crucial component of the ICP sample introduction system since it has a profound effect on transport efficiency, precision, and washout. Glass Expansion revolutionized the spray chamber design for the ICP industry with the Tracey and Twister cyclonic spray chamber, providing improved efficiency and reduced washout. Glass Expansion's unique Helix CT nebulizer interface, provides a zero dead volume seal that results in higher throughput compared to non-Glass Expansion designs.

Spray Chamber Types

DC Tracey™



Internal Volume, mL: 30
 Internal Baffle: No
 HF-resistant: No
 Precision: Very Good
 Purity: Good
 Material: Glass

Twinnabar™



Internal Volume, mL: 20
 Internal Baffle: Yes
 HF-resistant: No
 Precision: Very Good
 Purity: Good
 Material: Glass

Tracey™



Internal Volume, mL: 50
 Internal Baffle: No
 HF-resistant: No
 Precision: Very Good
 Purity: Good
 Material: Glass

Tracey™ TFE



Internal Volume, mL: 50
 Internal Baffle: No
 HF-resistant: Yes
 Precision: Good
 Purity: Good
 Material: PTFE

Twister™



Internal Volume, mL: 50
 Internal Baffle: Yes
 HF-resistant: No
 Precision: Excellent
 Purity: Good
 Material: Glass

Twister™ TFE



Internal Volume, mL: 50
 Internal Baffle: Yes
 HF-resistant: Yes
 Precision: Very Good
 Purity: Good
 Material: PTFE

Cinnabar™



Internal Volume, mL: 20
 Internal Baffle: No
 HF-resistant: No
 Precision: Very Good
 Purity: Good
 Material: Glass

Tracey™ PFA44



Internal Volume, mL: 44
 Internal Baffle: No
 HF-resistant: Yes
 Precision: Good
 Purity: Excellent
 Material: PFA

Helix CT™ - The Modern Interface Between Nebulizer and Spray Chamber

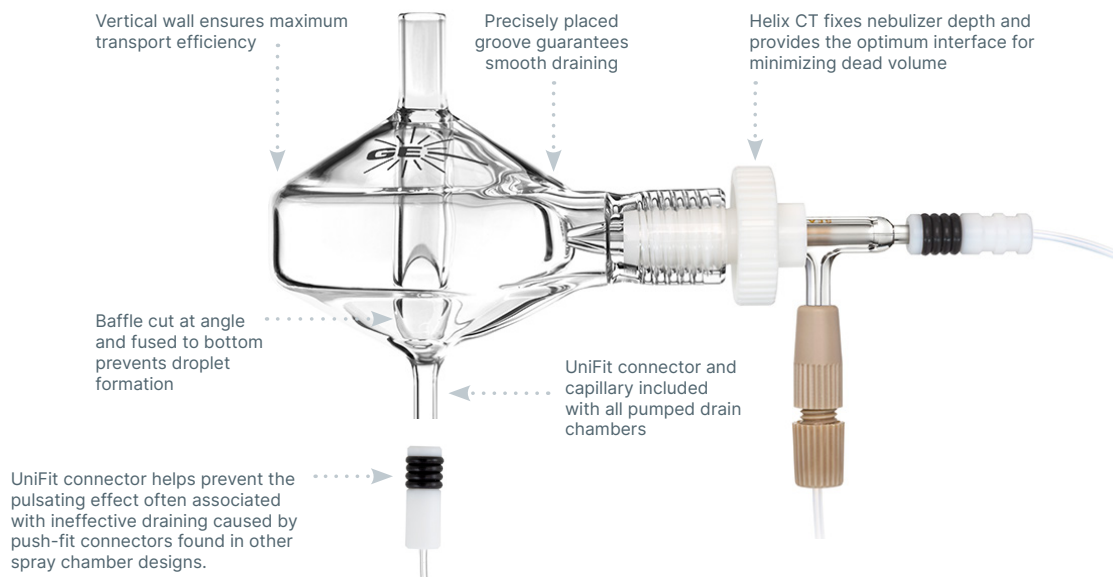

Traditionally, ICP-OES and ICP-MS sample introduction systems have relied on o-rings to form a gas-tight seal between the nebulizer and spray chamber. There are several drawbacks with an o-ring seal, such as:

- Potential for contamination due to dead volume around the o-ring seal.
- Chemical resistivity of strong acids and organic solvents.
- Even the most chemically resistant O-rings are prone to wear and tear and require regular replacement, which is time-consuming and often requires the use of tools.
- Bonding to the nebulizer can result in breakage.

Glass Expansion Helix CT spray chamber with ConstantTorque™ technology, provides a constant, reproducible, inert, gas-tight seal between the nebulizer and spray chamber.

The main feature of the Helix CT spray chamber is the **Helix locking screw with built-in torque control mechanism** that allows for a consistent seal of the PTFE ferrule against the nebulizer –making it impossible to overtighten or undertighten while ensuring a gas-tight seal each and every time.

A PressFit PTFE ferrule provides a chemically inert seal around the nebulizer, which is immune to strong acids and organic solvents routinely used in ICP sample preparation.

The Helix CT cyclonic spray chamber by Glass Expansion, therefore, eliminates all the drawbacks of the o-ring nebulizer seal, while improving user safety by preventing broken nebulizers.

Helix CT nebulizer interface is also simple to use:

- Fully insert the nebulizer into the Helix CT interface, until the nebulizer side-arm comes into contact with the molded-in positive stop.
- Hand-tighten the Helix CT locking screw until the ConstantTorque mechanism clicks, indicating a secure, gas-tight seal.

Glass Expansion equips all of its cyclonic spray chambers with the Helix CT interface as standard.

Part Number	Description
70-803-1439	Helix CT Locking Screw with Seal
70-803-1456	Helix CT Seal (PKT. 4)



HydraMist™ Simultaneous Cold Vapor/Pneumatic Nebulization Spray Chamber

The Glass Expansion HydraMist is a sensitive, simple-to-use spray chamber for Inductively Coupled Plasma (ICP) that allows simultaneous operation of both conventional pneumatic nebulization and cold-vapor/hydride generation. Cold vapor generation can provide more than 10-fold improvement in sensitivity on ICP for cold vapor forming elements such as As, Sb, Se, and Hg. The generation of volatile species of these elements results in increased analyte loading of the analytical plasma giving lower detection limits.

The design of the HydraMist spray chamber is based upon Glass Expansion's industry-standard cyclonic spray chamber, giving excellent sensitivity and short-term analytical precision with fast washout. The HydraMist spray chamber features a secondary inlet port that mixes the aerosolized sample and liquid reductant inside the spray chamber for rapid conversion of the As, Sb, Se, and Hg analytes into volatile hydride species. The unique drain design ensures fast, complete removal of waste from the spray chamber, eliminating excess hydrogen build-up that causes sample reflux degrading analytical precision.

The HydraMist Spray Chamber Features:

- The same outstanding short-term analytical precision and washout as other Glass Expansion cyclonic spray chambers
- Fast and complete vapor phase formation of volatile As, Se, Sb, and Hg species for the best detection limits in hydride generation mode
- A unique drain design to eliminate hydrogen build-up and sample reflux that degrades short-term precision
- Economic, just replace your current spray chamber and keep your existing nebulizer
- Improve productivity by analysing non-hydride forming elements and cold vapor elements simultaneously, avoiding system shutdowns to change over between the hydride generator accessory and conventional pneumatic nebulization

HydraMist Kit

Agilent® 5000 ICP-OES Series	KT-1157
Analytik Jena® PQ 9000	KT-1157
PerkinElmer® Avio 200/500	KT-1157
PerkinElmer® Avio with HTS system	KT-2742
PerkinElmer® Optima 8000/8300 DV	KT-1162
PerkinElmer® Optima 4000/5000/7000 DV	KT-1162
Shimadzu® ICPE 9000/9800	KT-1157
Spectro™ Arcos II SOP/EOP and Blue EOP/SOP	KT-1160
Thermo Scientific™ PRO	KT-1160
Thermo Scientific™ Duo 7600	KT-1156
Thermo Scientific™ Duo 6000/7200/7400	KT-1179

* Note: Nebulizer is not included in HydraMist Kit.

Simple Mode

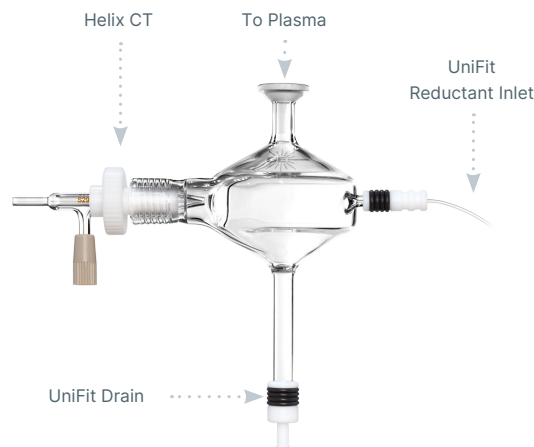

Sensitive Mode

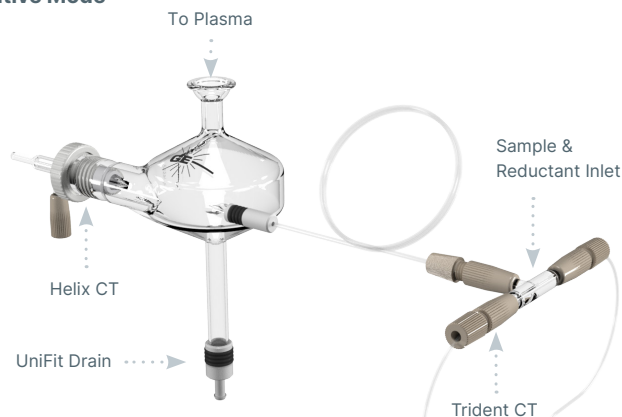

Pneumatic Nebulization

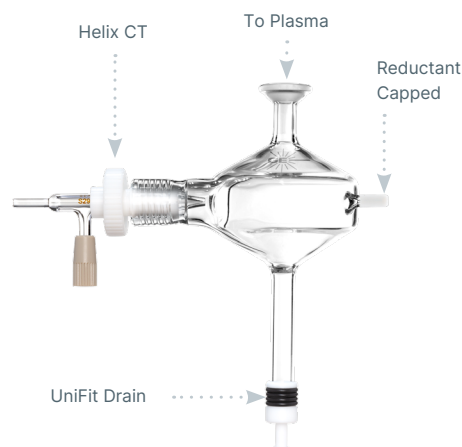

Spray Chamber Selection Guide

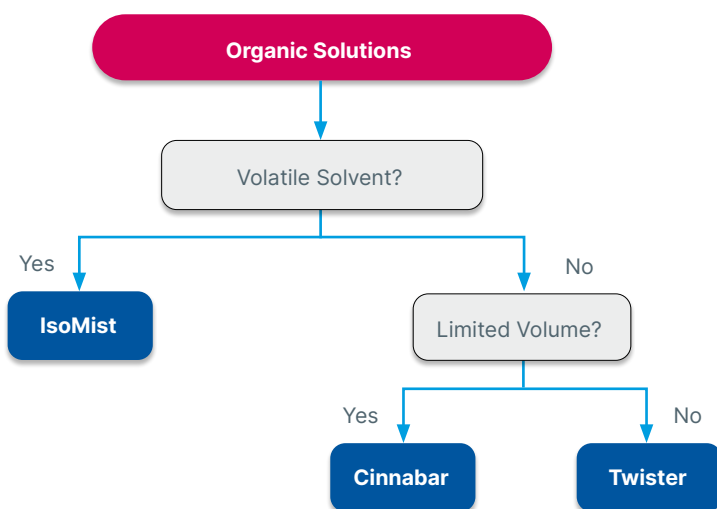
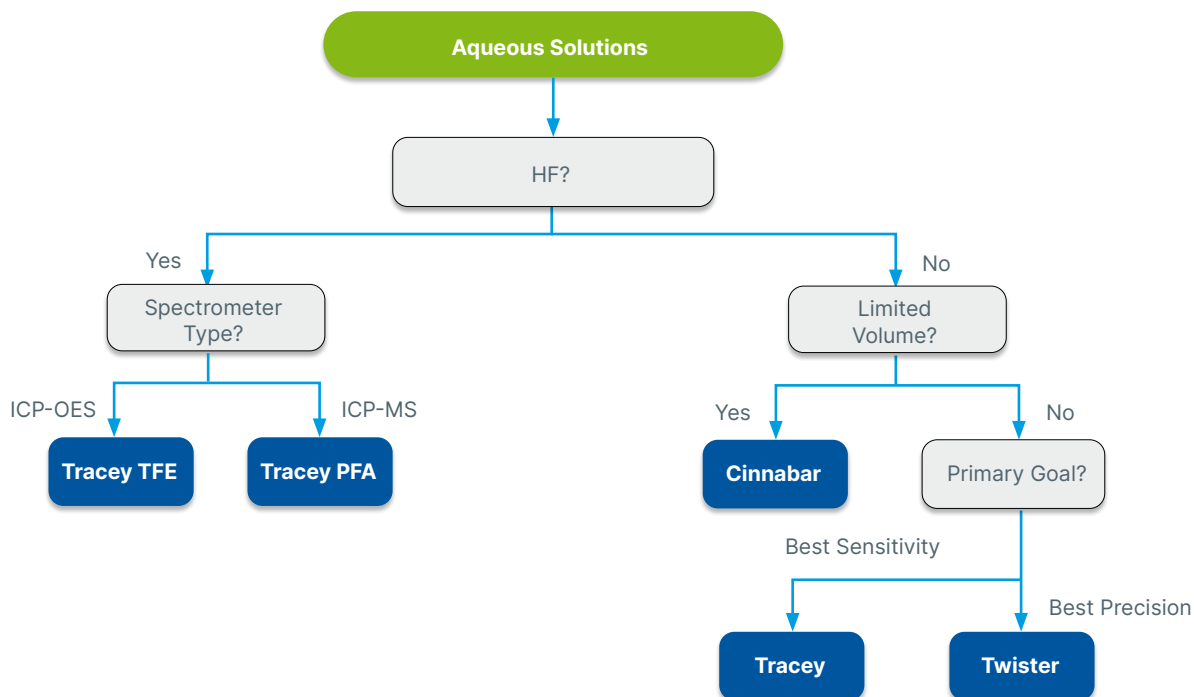

D-Torch™ (Demountable Torch)

The D-Torch is a revolutionary demountable torch design. It provides the benefits of a fully demountable torch at a significantly lower cost. Interchangeable outer tubes made of quartz or ceramic are available. The quartz tube is ideal for most aqueous applications and, since the outer tube is usually the first to wear, you can make a significant saving by replacing just the outer tube rather than the whole torch.

The ceramic outer tube is of particular benefit for the analysis of samples with high salt content or wear metals in engine oils, where quartz outer tubes often suffer from short lifetime. The ceramic outer tube has a much longer lifetime, greatly reducing interruptions and downtime due to torch failure. The D-Torch uses the same mounting system as the standard fixed torch so there is no additional cost or complexity to install it.

- Demountable outer tube – why replace the entire torch when just the outer tube wears?
- Interchangeable quartz and ceramic outer tubes.
- Much lower cost than other demountable torches.
- Interchangeable injectors for aqueous, organics, high dissolved solids or HF applications.

* The D-Torch is covered by US Patent 8,232,500 B2

The D-Torch models suited for the Agilent® 5000 Series, PerkinElmer® Avio 200/500, Thermo Scientific™ PRO and Spectro™ Arcos II and Blue incorporates the same easy to use, self-aligning and locking features of the standard torch in a robust cost effective design.

Complete D-Torch



Injectors



Outer Tubes



Torch Body



Semi Demountable Torch



- Highly accurate construction
- Lower running cost than one-piece torches

Usually comprises a quartz torch body, a torch adaptor, an injector and GazFit connectors. All these parts are replaceable, making the semi demountable torch more cost effective than the fixed quartz torch. The design of the torch for standard analyses and HF analyses is the same, with only the injector material changing. For aqueous and organics analyses use a quartz injector, while for HF analyses use an alumina injector. Hence simply interchange between quartz and alumina injectors for appropriate analyses. Several internal diameters for both quartz and alumina injectors are also available.

Fixed Quartz Torches (One Piece)



- Precise quartz construction
- Wide range held in stock
- Simple to use
- Lowest initial cost

RF Coils – more efficient energy transfer

Glass Expansion Coils are produced from the highest quality raw materials and plated using prescribed methods to obtain maximum RF (Radio Frequency) transmission efficiency. There are numerous papers published on RF transmission with regard to conductor and coating resistance.

The torch box environment is highly corrosive, causing bare copper to corrode quickly and accumulate buildup, reducing coil conductivity and increasing resistance. Copper is used as the base material of all commercially available coils but different manufactures use different plating materials. Silver has the best conductance and gold the best corrosion resistance. Many platers use brighteners for a shiny finish, but high-purity silver and gold result in a dull appearance. Glass Expansion uses high-purity metals and polishes coils after plating for smoothness and reduced resistance, also enhancing visual appeal.

Why Change your RF Coil?

- Regular replacement of corroded coils reduces the load on the RF generating system.
- Changing corroded coils increases energy transfer, resulting in a more robust plasma and generally higher analytical line intensities.

Advantages of Glass Expansion RF Coils

- High quality and consistent plating of our coils promotes extended coil life.
- Each coil is supplied on a plastic former ensuring correct dimensions and easier installation.
- Each coil is supplied in a special protective container to ensure correct dimensions are maintained, and the coil arrives corrosion free.
- Optimal alignment of the RF coil mitigates outer tube devitrification.



Glass Expansion Installation Kits for RF Coils

- Incorrect alignment of the torch in the coil will dramatically reduce torch life. The Glass Expansion Installation Kits help ensure correct alignment and maximum torch life.
- Correct alignment of the RF Coil with respect to the torch body reduces devitrification of the outer tube.
- Re-usable alignment tools are available separately to ensure correct installation of the coil every time.
- Our easy to follow Do-It-Yourself installation instructions save you time, and the cost of a service call.

All kits contain:

- An Installation Kit – Aligns coil to torch mounting bracket.
- Required Spanner/s – Designed specifically for each instrument.
- Do-It-Yourself instructions.



ICP-MS Cones



Our ICP-MS interface cones are made from ultra-pure metals sourced from specialty smelters. Our highly experienced machinists use state-of-the-art CNC machines and electron beam welding, which offer precise control, deep penetration, and minimal heat-affected zones compared to other welding techniques, to provide cones with the finest tolerances for the highest quality.

We supply cones for all of the popular ICP-MS models and, to make sure you get all the support you need, we have a staff of technical experts and a fully equipped ICP-MS laboratory for testing and evaluation.

Satisfaction guarantee:

We guarantee our products to meet or exceed performance expectations.

Refurbishment:

Extend the life of your platinum cones with our refurbishment program. In many cases, a platinum cone can be refurbished multiple times and its lifetime greatly extended.

Platinum reclaim:

If your platinum cone cannot be refurbished, we will provide a rebate for the value of platinum in the cone.

ConeGuard

The ConeGuard Thread Protector protects the cone thread from corrosive cleaning solutions and greatly extends cone life.

ICP-MS Cone Resource Guide

Our ICP-MS Cone Resource Guide answers all the questions you ever had about cones. It includes the “why” and “how” of selecting the right cones, details on the advantages of different cone materials, and tips on care and maintenance.

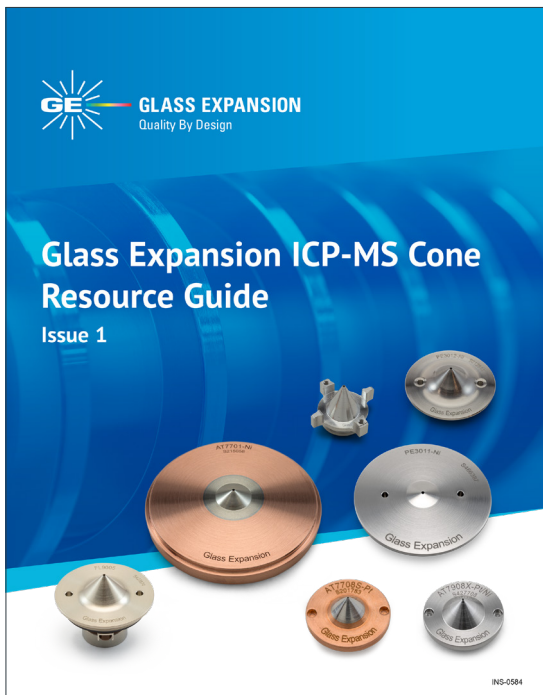

Includes:

- About Glass Expansion ICP-MS Cones
- Platinum Cone Refurbishing
- Cone Material Guidelines
- Cones by ICP Model
- Cone Conditioning, Gasket & O-ring replacement guidelines
- Cone Maintenance

[Click here](#) to view the ICP-MS Cone Resource Guide.

IsoMist™ Programmable Temperature Spray Chamber



The IsoMist programmable temperature controlled cyclonic spray chamber now features an improved thermodynamic design providing an extended temperature range and faster cool-down, so your ICP is ready to go sooner.

The IsoMist is a compact, convenient and maintenance-free temperature controlled sample introduction system for all ICP's.

Improved Analytical Stability with Precise Temperature Control

On the IsoMist, the spray chamber temperature is accurately controlled through an improved thermodynamic design using a multi-stage peltier device. The spray chamber temperature is settable in 1°C increments from -25°C to 80°C guaranteeing optimum conditions can be used for any application.

Reduce Oxide Interferences in ICP-MS

Using the IsoMist spray chamber at sub-ambient temperatures on an ICP-MS, the sample is cooled, less water vapor is transferred to the plasma resulting in lower oxide formation and reduced polyatomic (ArO, ArOH) interferences. Less oxides in the plasma mean fewer interferences, improving accuracy and detection limits.

Perfect for Naphtha and Gasoline Analysis

For volatile solvents, a lower sample introduction temperature reduces nebulization efficiency avoiding quenching of the plasma from solvent over-loading. With a minimum operating temperature of -25°C, analyzing volatile organic solvents such as naphtha and gasoline by ICP is even easier.

Improve Analytical Stability with Constant Spray Chamber Temperature

Fluctuations in the lab temperature affects sample viscosity and nebulization efficiency. Maintaining the sample introduction system at a constant and stable temperature improves analytical reproducibility, enhances throughput and lowers operating costs by reducing the need to re-run samples when a check standard drifts outside the acceptable upper or lower limits.

Elevated Sample Introduction Temperatures Enhances Sensitivity

The sensitivity for many analyses can be enhanced by operating the spray chamber at elevated temperatures - especially important for limited sample volumes. Heating the spray chamber also helps with the analysis of viscous samples such as lubricants and edible oils.

A Spray Chamber Optimized for Analytical Performance

The IsoMist incorporates a proven cyclonic spray chamber design in glass, quartz and HF resistant PFA with Helix CT interface. Compared to a Scott type spray chamber, cyclonic spray chambers are more sensitive and have better washout. The IsoMist includes the Helix CT nebulizer interface, which eliminates sample contamination and ensures easy nebulizer removal for routine nebulizer cleaning. The Helix CT nebulizer interface also has zero dead volume, reducing carry-over and improving washout between samples. With a positive stop built-in, Helix CT ensures correct and reproducible nebulizer insertion depth for constant nebulizer performance.



Easy to Use Software

For maximum convenience, the IsoMist can be controlled from a PC via USB or Bluetooth wireless interface. The spray chamber temperature can be monitored during an analytical run with time vs temperature plot on your PC screen.

Elegant, Ergonomic and Compact

The IsoMist is an elegant, compact, stand-alone system manufactured from materials resistant to attack from acids and solvents commonly used in ICP analysis. By using a peltier to maintain the spray chamber temperature, the messy, noisy and high-maintenance refrigerated circulating baths used with jacketed spray chambers has been eliminated. The compact design means all IsoMist Programmable Temperature Controlled Spray Chambers are compatible with virtually any ICP-OES or ICP-MS.

Guardian™ In-Line Sample Filter



If there are particulates in your samples, there is a risk that they may get trapped in the narrow bore sample tubing or within the nebulizer. The Guardian In-Line Sample Filter provides a simple and effective way to eliminate this risk. This filter is easily inserted in the sample tubing between the autosampler probe and the nebulizer. It incorporates a 120 micron PolyComb filter and is suitable for use with 1/16 inch (1.6mm) OD or 1.3mm OD sample tubing.

The purpose-built clog-resistant design is ideal for ICP samples. Unlike sintered or frit style filters, the linear honeycomb structure makes the PolyComb filter resistant to clogging from particulates. Any particle build-up is easily removed by back-flushing using the Eluo Adaptor 70-803-1160. And the PEEK material is suitable for use with all of the most common ICP solutions.



Eluo Adapter For In-Line Filter

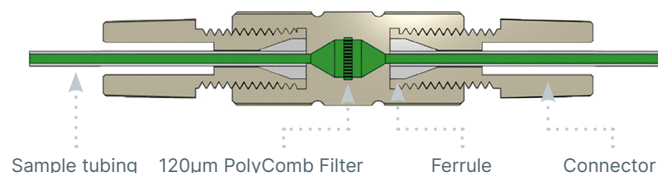

Guardian In-Line Sample Filter

In-Line Filter	70-803-1108
Eluo Adaptor for In-Line Filter	70-803-1160
Replacement Viton O-rings for Eluo Adaptor (PKT 10)	70-V-009
Fitting Seal 1/16 (PKT 10)	70-803-0749
Fitting Seal 1.3mm (PKT 10)	70-803-0748
Ratchet Connector	70-803-1350

Guardian™ In-Line Non-Return Gas Filter



The new Guardian In-line Non-Return Gas Filter provides protection for your ICP system in two ways:

1. A non-return valve prevents acidified sample or rinse solution syphoning into the instrument gas box.
2. 30µm PolyComb filter protects the nebulizer from particulates in the instrument gas supply.

The Guardian In-line Non-Return Gas Filter is positioned between the Argon inlet on the Direct Connection nebulizer and the gas supply fitting on the instrument. The In-line Non-Return Filter has a one-way valve that allows argon to flow from the instrument into the nebulizer, but prevents liquid syphoning into the instrument. A unique PolyComb 30µm filter design protects the nebulizer from particulates from the gas supply or from worn or damaged fittings in the gas lines. Unlike Sintered or Frit style filters, the linear honeycomb structure makes PolyComb most resistant to particulate and dissolved solid clogging.

Syphoning of the sample or rinse solution into the nebulizer argon control module on your ICP can occur at the end of an analytical run when the nebulizer gas pressure is turned off and there is liquid in the sample flow path. It is made worse if the autosampler probe stays in the rinse position at the end of a run.

An overlooked issue when using an autosampler for unattended overnight runs is its potential to silently and invisibly damage your ICP instrument. Acidified solution in the instrument's argon control module can corrode electronic sensors in mass flow controllers and damage regulators, leading to costly repairs and unplanned downtime.

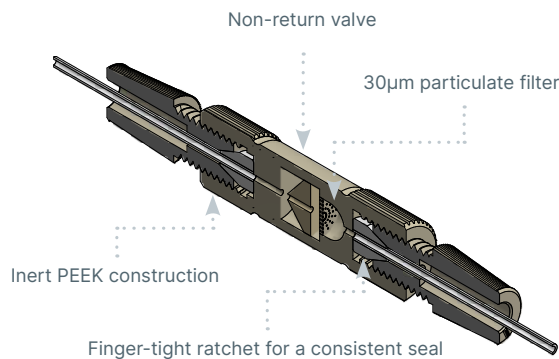

Guardian In-Line Non-Return Gas Filter

Guardian DC In-Line Non-Return Gas Filter	70-803-1942
Guardian In-Line Non-Return Gas Filter	70-803-1362

*Choose P/N 70-803-1942 if using a DC nebulizer model.

Eluo™ Nebulizer Cleaning Tool

As easy as 1, 2, 3

1. Fill with solvent



2. Insert nebulizer



3. Clean nebulizer



Particle build-up in a nebulizer capillary and tip causes sample flow to be constricted, reducing nebulizer efficiency and performance. Now, blocked nebulizers can be safely and easily restored to optimum performance with a revolutionary cleaning instrument – the Eluo.

The Eluo is designed to efficiently deliver a cleanser through the nebulizer capillary to dislodge particle build-up and thoroughly clean the nebulizer. One simple action does it all. No more messy procedures or shattered nebulizers in ultrasonic baths. Use the Eluo regularly to maintain nebulizer performance and prolong nebulizer life. Every lab should have an Eluo.

The Eluo can also be conveniently used to clean the Inline Particle Filter P/N 70-803-1108 with the addition of Adaptor P/N 70-803-1160.

We have found that using a dilute concentration of Fluka RBS-25 (manufactured by Sigma-Aldrich, and is available from most suppliers of laboratory chemicals) is the best cleaning solution. Stubborn clogs may require an overnight soak or additional cleaning with nitric acid.

Eluo Nebulizer Cleaning Tool

Eluo for Glass concentric Nebulizers	70-ELUO
Eluo HF for OpalMist or DuraMist	70-ELUO-OPD
Eluo Barrel	703-0058
Eluo Plunger	70-703-0070
Eluo HF Nebulizer Holder	70-803-0932
Eluo Nebulizer Holder for Glass concentric Nebulizers	70-703-0069
Eluo Adaptor for Inline Filter	70-803-1160
O-ring Kit for Eluo (2 sets)	70-0806

Elegra™ Argon Humidifier

To Spectrometer gas port
 To Nebulizer
 Gas Inlet
 Gas Outlet



An Argon Humidifier is commonly used in ICP analyses involving samples with high concentrations of dissolved solids. It helps to alleviate salt deposits in the nebulizer and torch injector, allowing uninterrupted and maintenance-free operation.

- Compact, cost-effective design.
- No heating or electric power required.
- Non-pressurized water reservoir.
- An easy-to-use bypass switch allows you to take the Elegra off-line without disconnecting argon lines. (Not available with Elegra Dual)
- Highly efficient membrane humidification technology.
- Improved signal stability for samples with high TDS.
- Simple to install, use and maintain.
- Improves productivity by reducing down-time for cleaning.
- Inert metal-free construction eliminates contamination.
- Maximum and minimum fill marks ensure that you are always operating under optimum conditions.
- Compatible with all ICP-OES and ICP-MS models. Direct connection to argon outlet provided for most models.
- Elegra Dual configuration available for ICP-MS instruments using auxiliary argon.

Elegra Argon Humidifier

O-ring for Capricorn or Elegra Cap (PKT 3)	70-V-225
Elegra Stand	70-803-1581
Elegra Membrane	70-803-1286
Elegra Reservoir	70-803-1257

[Click here](#) to view the Elegra™ Landing page and ordering information.

High Efficiency Sample Introduction System (HE-SIS)

Originally designed as a highly efficient single-cell sample introduction system, Glass Expansion's HE-SIS has been redesigned to provide superior performance across a wide variety of applications, including single-cell, single particle, nanoparticle, and low-volume sample studies, with up to 95% transport efficiency.

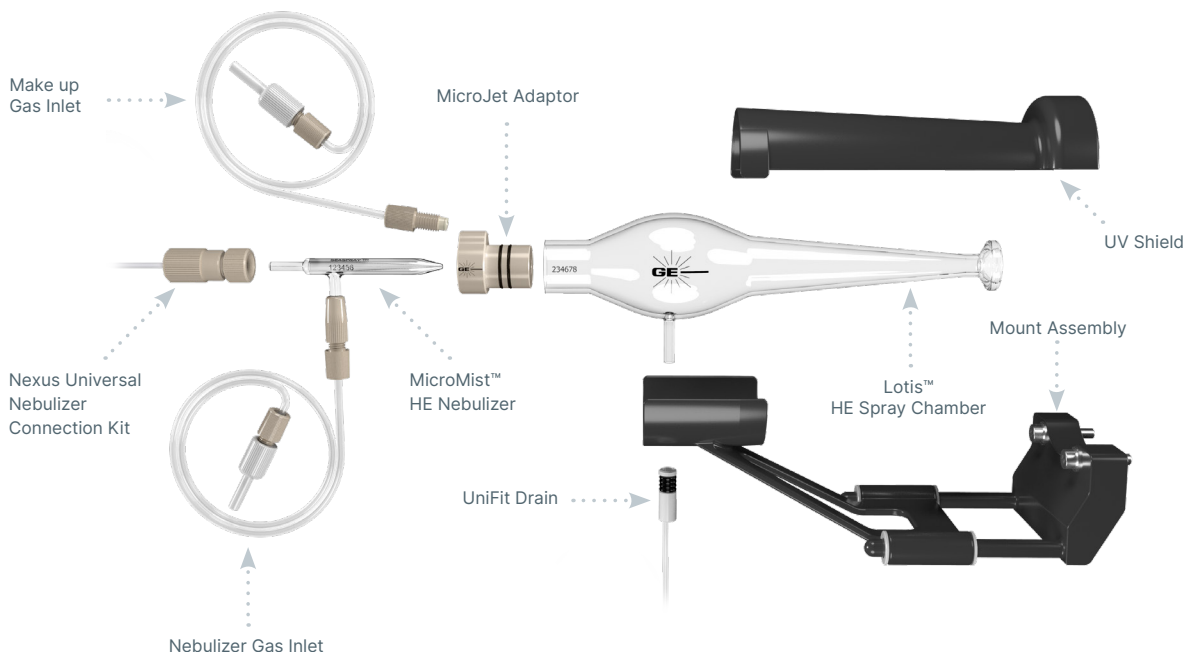

Key HE-SIS Components

MicroMist™ High Efficiency (HE) Nebulizer

This specially designed concentric glass nebulizer is based on our popular MicroMist design, capable of efficiently nebulizing limited sample volumes at low sample and argon gas flow rates.



Patent-pending MicroJet™ Gas Adaptor

Our patent-pending MicroJet gas adaptor shapes the nebulizer aerosol plume to reduce sample deposition on the spray chamber walls and enhance transport efficiency.

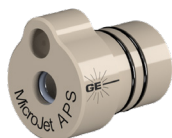

Lotis™ High Efficiency (HE) Spray Chamber

The Lotis HE spray chamber directly couples to the ICP-MS torch, providing the highest transport efficiency and excellent washout between samples.



High Efficiency Sample Introduction System

Agilent® ICP-MS	KT-1155
Analytik Jena® PlasmaQuant MS	KT-2747
PerkinElmer® NexION 1000/2000/2200/5000	KT-1184
PerkinElmer® NexION 300/350	KT-1204
Thermo Scientific™ Q/RQ/TQ ICP-MS	KT-1172
Thermo Scientific™ Neoma MC-ICP-MS	KT-1172
Thermo Scientific™ X Series	KT-1213
Thermo Scientific™ Neptune/Element	KT-1215
TOFWERK icpTOF	KT-1172
Nu ATTOM	KT-1205
Nu Instruments® Vitesse TOF-ICP-MS	KT-1219

Trident CT™ In-Line Reagent Additions Kits

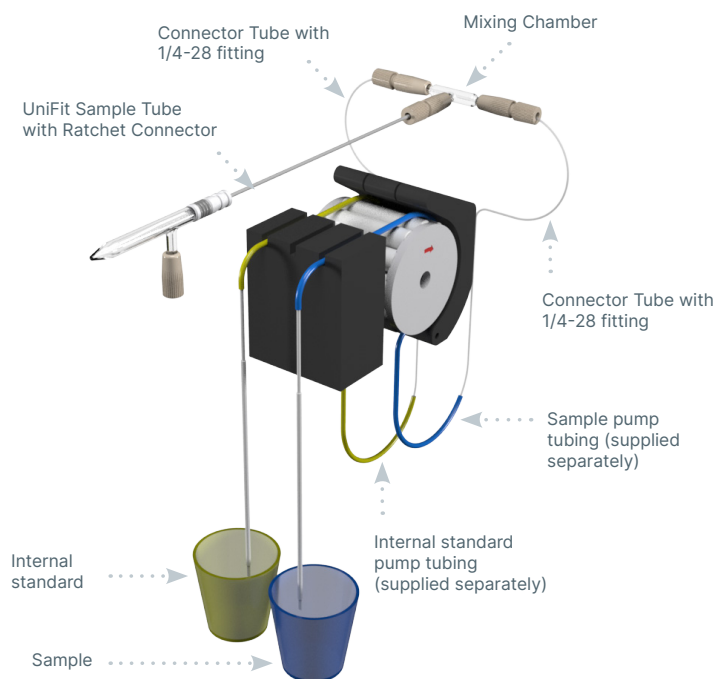

Internal standards are often used in ICP Spectrometry to improve stability. The internal standardization process involves the addition of a known concentration of a particular element to every sample and can be a very time-consuming procedure. The Glass Expansion Trident Kits allow the internal standard to be automatically mixed with each sample during sample introduction, saving considerable sample preparation time.

The Trident CT mixing chamber is based on the industry-proven design of the Trident, but with the addition of Glass Expansion's ConstantTorque (CT) to provide a simple-to-use, leak-free connection for both the internal standard and sample, every time.

The heart of the kit is the mixing chamber, designed with zero dead volume CT fittings. With other mixing chambers, worn or improperly fitted connections leak, inject a stream of air bubbles into the nebulizer flow, degrading short-term analytical precision (%RSD). By using CT ratchet-style fittings, the Trident CT eliminates air leaks, optimizing analytical performance.

Trident CT In-Line Reagent Additions Kit for non-HF solutions:

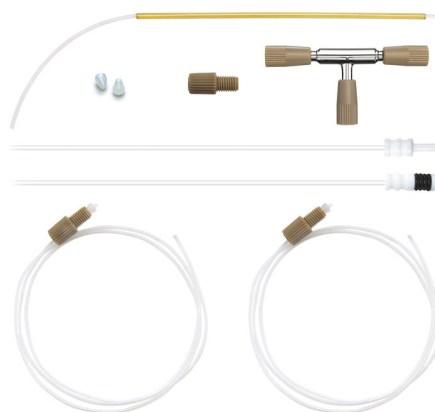

The Trident CT features:

- Compact, efficient mixing chamber ensures complete mixing of the sample and reagent.
- CT fittings for a durable, leak-free seal on all connections.
- Zero dead volume connections.
- Completely modular so that damaged or lost components can easily be replaced.

Check the Trident Dilution Factor Calculator on our website to find out the sample and internal standard dilution factors for selected combinations of pump tubing.

The peristaltic pump tubing is not supplied as part of the Internal Standard Kit but can be ordered separately.

Trident Internal Standard Kit for HF solutions:



In-Line Reagent Additions Kits

Trident CT In-Line Reagent Additions Kit 60-703-1179

Trident Internal Standard Kit for HF (original design) 60-808-1150

[Click here](#) to view the consumables for the Trident CT™ In-Line Reagent Additions Kits.

Laser Ablation

P/N: 21-809-4309



P/N: 70-803-1600



P/N: 31-808-4034



P/N: 20-809-4550



P/N: 21-809-2801



P/N: 31-808-4289



P/N: 31-808-4107



P/N: 31-808-3863
OD: 4mm
ID: 2mm



S13 (13 mm) cup Adaptors

P/N: 31-800-1007
ID: 4mm



P/N: 21-809-4140



P/N: 21-809-0965C
OD: 6mm
ID: 4mm



P/N: 31-808-3045
OD: 4mm
ID: 2mm



GazFit Connectors



GazFit Union Connectors (for rigid walled tubing)

GazFit Union 4mm (PKT.2)	GAZ-04U
GazFit Union 6mm (PKT.2)	GAZ-06U
GazFit Union 8mm (PKT.2)	GAZ-08U



Standard GazFit Connectors (for soft walled tubing)

GazFit Connectors for 4mm OD side arm (PKT.4)	GAZ-04
GazFit Connectors for 5mm OD side arm (PKT.4)	GAZ-05
GazFit Connectors for 6mm OD side arm (PKT.4)	GAZ-06
GazFit Connectors for 8mm OD arm (PKT.2)	GAZ-08
GazFit Connectors, 2 for 6mm OD side arms, 2 for 4mm OD side arms (PKT.4)	GAZ-0604
GazFit Connectors for 6mm OD side arm with connection for 1/8inch ID tubing (PKT.4)	GAZ-06-3.2B

Guardian™ Autosampler Probes

The unique design of the robust tip—which combines drip-resistance and built-in particle filtering—helps to prevent cross-contamination during probe movement and blockages in your nebulizer and capillary tubing. Constructed entirely from Ceramic, PEEK and PTFE, the Guardian autosampler probe also provides exceptional resistance to strong acids and solvents. The Guardian probe has an ID of 1.0mm, with interchangeable UniFit sample capillaries that are available in IDs of 0.3, 0.50, 0.75 and 1.0mm.

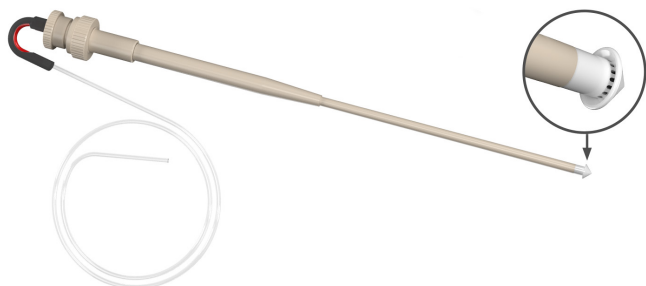

Benefits:

- Robust tip design eliminates crushed and damaged tips due to misalignment.
- Drip-resistance prevents cross contamination of samples, especially with oils.
- Built-in particle filtering holds back particulates from blocking the line.
- Completely inert design, all Ceramic, PEEK and PTFE construction.
- Interchangeable UniFit sample lines available in various IDs (e.g. 0.3, 0.50, 0.75 & 1.0mm)
- Designed to suit Cetac, Agilent, PerkinElmer, Shimadzu, Aim Lab, and Thermo Scientific Autosamplers.

Guardian Probe with Connecting Line

Guardian Probe for SPS3/SPS4/AIMS, 0.75mm Probe Connecting Line (Red)	70-803-1957
Guardian Probe Cetac ASX-200/500/800, 0.75mm Probe Connecting Line (Red)	70-803-1803
Guardian Probe for PerkinElmer AS93, 0.75mm Probe Connecting Line (Red)	70-803-2836
Guardian Probe for PerkinElmer S20 Series, 0.75mm Probe Connecting Line (Red)	70-803-2097
Guardian Probe for PerkinElmer S10, 0.75mm Probe Connecting Line (Red)	70-803-2851

Guardian Probe only

Guardian Probe for SPS3/SPS4/AIMS	70-803-2008
Guardian Probe for Cetac ASX-200/500/800 Series	70-803-1787
Guardian Probe for Cetac ASX-112FR	70-803-2029
Guardian Probe for AS93	70-803-2819
Guardian Probe for PerkinElmer S20 Series	70-803-2754
Guardian Probe for PerkinElmer S10	70-803-2849

Probe Connecting Lines for all Autosamplers (excluding ASX-112FR)

Probe Connecting line 1.0mm ID (Green)	70-803-1721
Probe Connecting Line 0.75mm ID (Red)	70-803-1714
Probe Connecting Line 0.5mm ID (Blue)	70-803-1852
Probe Connecting Line 0.3mm ID (Black)	70-803-1853

Probe Connecting Lines for ASX-112FR

Probe Connecting Line 0.18mm ID (Black)	70-803-2030
Probe Connecting Line 0.18mm ID with EzyFit (Green/Black)	70-803-2085

Autosampler Probes



Suitable for Cetac ASX-200/500/800 Series and PerkinElmer S20 Series

PTFE Encapsulated Carbon Fibre Probe 0.25mm ID with EzyFit	70-803-1088
Polyimide sheathed Autosampler Probe 0.5mm ID	60-808-1186L
PTFE Encapsulated Carbon Fibre Probe 0.25mm ID	70-803-1523
PTFE Encapsulated Carbon Fibre Probe 0.5mm ID	70-803-0784
PTFE Encapsulated Carbon Fibre Probe 0.5mm ID with UniFit	70-803-1380
PTFE Encapsulated Carbon Fibre Probe 0.75mm ID with ratchet fitting	70-803-1443
PTFE Encapsulated Carbon Fibre Probe 0.75mm ID	70-803-1880
PTFE Encapsulated Carbon Fibre Probe 1.0mm ID with ratchet fitting	70-803-0793
PTFE Encapsulated Carbon Fibre Probe 1.0mm ID	70-803-1879

For Cetac ASX 110

PFA sheathed Autosampler Probe 0.25mm ID with EzyFit	70-803-1072
PFA sheathed Autosampler Probe 0.25mm ID with UniFit	70-803-1073
PTFE Sheathed Carbon Fibre Probe 0.18mm ID with UniFit	70-803-1684
PTFE Encapsulated Carbon Fibre Probe 0.3mm ID with UniFit	70-803-1191
PTFE Encapsulated Carbon Fibre Probe 1.0mm ID	70-803-1182

For Agilent® SPS 3/SPS 4

PTFE Encapsulated Carbon Fibre Probe 0.25mm ID	70-803-0910
PTFE Encapsulated Carbon Fibre Probe 0.50mm ID	70-803-0909
PTFE Encapsulated Carbon Fibre Probe 0.75mm ID	70-803-0908
PTFE Encapsulated Carbon Fibre Probe 1.0mm ID	70-803-0853

For Agilent® I-AS

PTFE Encapsulated Carbon Fibre Probe 0.25mm ID with UniFit, 1100mm total length	60-703-1010
PTFE Encapsulated Carbon Fibre Probe 0.3mm ID with UniFit, 686 mm total length	60-703-1009
PTFE Encapsulated Carbon Fibre Probe 1.0mm ID	60-703-0533

For PerkinElmer® S10 or AS93+

PTFE Encapsulated Carbon Fibre Probe 0.25mm ID	70-803-1071
PTFE Encapsulated Carbon Fibre Probe 0.5mm ID	70-803-1440
PTFE Encapsulated Carbon Fibre Probe 1.0mm ID	70-803-0816

For Shimadzu®

PTFE Sheathed Carbon Fibre Probe 0.75mm ID with UniFit, for Shimadzu® AS-10	70-803-1477
---	-------------

Glass DC Nebulizers

SeaSpray

400µL/min uptake A13-1-USS04

MicroMist

400µL/min uptake A13-1-UM04

200µL/min uptake A13-1-UM02

100µL/min uptake A13-1-UM01

50µL/min uptake A13-1-UM005

Conikal

1mL/min uptake A13-1-UC1



Quartz DC Nebulizers

SeaSpray

1mL/min uptake A13-1-QSS1



DC Nebulizers for HF

OpalMist

400µL/min uptake A13-1-PFA04

200µL/min uptake A13-1-PFA02

100µL/min uptake A13-1-PFA01

50µL/min uptake A13-1-PFA005



DC Nebulizers for HE-SIS

MicroMist HE

200µL/min uptake C13-1-UFT02

200µL/min uptake E13-1-UFT02



Peltier Controlled Cyclonic Spray Chambers

Glass Spray Chamber KT-1116

Quartz Spray Chamber KT-1116Q

PFA Spray Chamber KT-1116P



Spray Chambers

High Efficiency Sample Introduction System

HE-SIS for Agilent ICP-MS KT-1155



*Twister

50mL Cyclonic with Aux. 20-809-2574HE

*Requires adaptor KT-1104.



Quartz Scott Style

For 7900 UHMI 20-809-4144



Spray Chambers for HF

*Tracey PFA44

44ml Cyclonic with Aux. 20-809-2578

Spray Chamber Adaptor KT-1104

*Requires adaptor KT-1104.



Torches

Quartz Torches

with 1.0mm Injector 30-807-0558

with 1.5mm Injector 30-807-0557

with 2.0mm Injector 30-807-3608

with 2.5mm Injector 30-807-0556



Torch Options

Quartz Torch Bonnet 31-808-2577

Quartz Connector with Dilution Port 31-808-3217

Quartz Connector with 45deg Dilution Port 31-808-3280

Straight Quartz Connector 31-808-3288

Clamp (PKT 2) 70-803-0846



Torches

(continued)

Semi-Demountable Torch

with 2.4mm Quartz Injector 30-808-3853



Torch Options

Semi-Demountable Torch body 31-808-3857



1.0mm Tapered Quartz Injector 31-808-4172

1.5mm Tapered Quartz Injector 31-808-4173



2.4mm Tapered Quartz Injector 31-808-4168

1.0 mm Tapered Alumina Injector 31-808-4169



1.5 mm Tapered Alumina Injector 31-808-4170

2.4mm Tapered Alumina Injector 31-808-3855

2.4mm Sapphire Capillary Injector 31-808-4159



PEEK Injector Adaptor 31-808-4478

Viton O-rings for FDT/SDT ball joints (PKT 10) 70-V-011



RF Coils

Copper 70-900-7800C

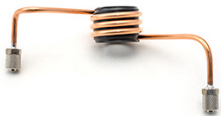

Silver 70-900-7800S



Gold 70-900-7800G



RF Coil Installation Kit 70-900-7500T



Cones

Sampler Cones

Nickel Sampler AT7701-Ni

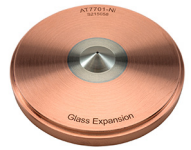

Nickel Sampler with Nickel plated base AT7701-Ni/Ni



Aluminium Sampler AT7701-Al



Platinum Sampler AT7706-Pt

Platinum Sampler (18 mm Insert) AT7706A-Pt



Platinum Sampler with Nickel plated base AT7706-Pt/NiP



Platinum Sampler with solid Nickel base AT7706-Pt/Ni

Platinum Sampler (15mm insert) with Nickel base AT7706B-Pt/Ni

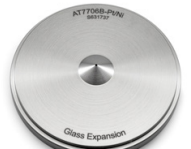

Platinum Sampler with Nickel plated base (Extended Life) AT7706L-Pt/NiP

Skimmer Cones

Nickel Skimmer for x-lens AT7902X-Ni



Aluminium Skimmer for x-lens AT7902X-Al



Platinum Skimmer for x-lens AT7908X-Pt



Cones

(continued)

Skimmer Cones (continued)

Platinum Skimmer with Nickel base for x-lens AT7908X-Pt/Ni



Nickel Skimmer for s-lens AT7702S-Ni

Copper Skimmer for s-lens AT7702S-Cu



Platinum Skimmer for s-lens AT7708S-Pt

Platinum Skimmer with Nickel base for s-lens AT7708S-Pt/Ni



Platinum Skimmer with Nickel base for m-lens AT8908M-Pt/Ni

Cone Options

Skimmer Cone Guard 70-803-1004

Long Life Pt Shield Plate AT5004

Graphite Gasket (PKT 3) AT7703

Retaining Ring AT7704



Brass Skimmer Adaptor base for m lens AT7905M-BR

Brass Skimmer Adaptor base for x lens AT7905X-BR

Stainless Steel Skimmer Adaptor base for x lens AT7905X-SS

Captive Screw M4 for Skimmer Base (PKT 3) 70-803-2061



Common Accessories

Elegra Argon Humidifier

Elegra Dual Argon Humidifier 70-803-1273



Elegra Stand 70-803-1581



Common Accessories

(continued)

Guardian In-Line Filters

Guardian DC in-line non-return gas filter 70-803-1942

Guardian in-line sample filter 70-803-1108

Eluo Adaptor for Inline Filter 70-803-1160



Trident Internal Standard Kits

Trident CT Standard Kit 60-703-1179

Standard Kit for HF 60-808-1150

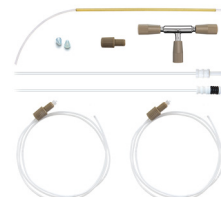

Magnifier Inspection Tool 70-803-1923



Autosampler Probes (See page 20-21 for complete list of probes)

For Agilent I-AS

PTFE Encapsulated Carbon Fibre Probe 0.25mm ID 60-703-1010

PTFE Encapsulated Carbon Fibre Probe 0.3mm ID 60-703-1009



For Cetac ASX-200/500/800 Series

Guardian Probe 0.75mm Probe Connecting Line (Red) 70-803-1803

Polyimide sheathed Autosampler Probe 0.5mm ID 60-808-1186L

PTFE Encapsulated Carbon Fibre Probe 0.5mm ID 70-803-0784

PTFE Encapsulated Carbon Fibre Probe 0.75mm ID 70-803-1443

PTFE Encapsulated Carbon Fibre Probe 1.0mm ID 70-803-0793



For SPS 3/SPS 4

Guardian Probe 0.75mm Probe Connecting Line (Red) 70-803-1957

PTFE Encapsulated Carbon Fibre Probe 0.75mm ID 70-803-0908

PTFE Encapsulated Carbon Fibre Probe 1.0mm ID 70-803-0853



Glass DC Nebulizers

SeaSpray

400µL/min uptake A13-1-USS04

MicroMist

400µL/min uptake A13-1-UM04
 200µL/min uptake A13-1-UM02
 100µL/min uptake A13-1-UM01
 50µL/min uptake A13-1-UM005

Conikal

1mL/min uptake A13-1-UC1



Quartz DC Nebulizers

SeaSpray

1mL/min uptake A13-1-QSS1



DC Nebulizers for HF

OpalMist

400µL/min uptake A13-1-PFA04
 200µL/min uptake A13-1-PFA02
 100µL/min uptake A13-1-PFA01
 50µL/min uptake A13-1-PFA005



DC Nebulizers for HE-SIS

MicroMist HE

200µL/min uptake C13-1-UFT02
 200µL/min uptake E13-1-UFT02



Peltier Controlled Cyclonic Spray Chambers

Glass Spray Chamber KT-1116
 Quartz Spray Chamber KT-1116Q
 PFA Spray Chamber KT-1116P



Spray Chambers

High Efficiency Sample Introduction System

HE-SIS for Agilent ICP-MS KT-1155



Spray Chambers

***Twister**

50mL Cyclonic with Aux. 20-809-2574HE

*Requires adaptor KT-1104.



Quartz Scott Style

For 7900 UHMI 20-809-4144



Spray Chambers for HF

***Tracey PFA44**

44ml Cyclonic with Aux. 20-809-2578
 Spray Chamber Adaptor KT-1104

*Requires adaptor KT-1104.



Torches

Quartz Torches

with 1.0mm Injector 30-807-0558
 with 1.5mm Injector 30-807-0557
 with 2.0mm Injector 30-807-3608
 with 2.5mm Injector 30-807-0556

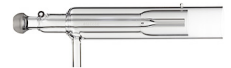

Torch Options

Quartz Torch Bonnet 31-808-2577
 Quartz Connector with Dilution Port 31-808-3217
 Quartz Connector with 45deg Dilution Port 31-808-3280
 Straight Quartz Connector 31-808-3288
 Clamp (PKT 2) 70-803-0846



Torches

(continued)

Semi-Demountable Torch

with 2.4mm Quartz Injector 30-808-3853



Torch Options

Semi-Demountable Torch body 31-808-3857



1.0mm Tapered Quartz Injector 31-808-4172

1.5mm Tapered Quartz Injector 31-808-4173



2.4mm Tapered Quartz Injector 31-808-4168

1.0 mm Tapered Alumina Injector 31-808-4169



1.5 mm Tapered Alumina Injector 31-808-4170

2.4mm Tapered Alumina Injector 31-808-3855

2.4mm Sapphire Capillary Injector 31-808-4159



PEEK Injector Adaptor 31-808-4478

Viton O-rings for FDT/SDT ball joints (PKT 10) 70-V-011



RF Coils

Copper 70-900-7800C



Silver 70-900-7800S



Gold 70-900-7800G



RF Coil Installation Kit 70-900-7500T



Cones

Sampler Cones

Nickel Sampler AT7701-Ni

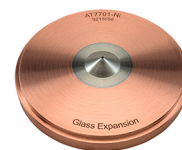

Nickel Sampler with Nickel plated base AT7701-Ni/Ni



Aluminium Sampler AT7701-Al



Platinum Sampler AT7706-Pt

Platinum Sampler (18 mm Insert) AT7706A-Pt



Platinum Sampler with Nickel plated base AT7706-Pt/NiP



Platinum Sampler with solid Nickel base AT7706-Pt/Ni

Platinum Sampler (15mm insert)with Nickel base AT7706B-Pt/Ni



Platinum Sampler with Nickel plated base (Extended Life) AT7706L-Pt/NiP

Skimmer Cones

Nickel Skimmer for x-lens AT7902X-Ni



Aluminium Skimmer for x-lens AT7902X-Al



Platinum Skimmer for x-lens AT7908X-Pt



Cones

(continued)

Skimmer Cones (continued)

Platinum Skimmer with
Nickel base for x-lens AT7908X-Pt/Ni



Nickel Skimmer for s-lens AT8902S-Ni



Copper Skimmer for s-lens AT8902S-Cu

Platinum Skimmer for s-lens AT8908S-Pt/Cu

Platinum Skimmer with
Nickel base for s-lens AT8908S-Pt/Ni

Platinum Skimmer with
Nickel base for m-lens AT8908M-Pt/Ni



Cone Options

Skimmer Cone Guard 70-803-1004

Long Life Pt Shield Plate AT5004

Graphite Gasket (PKT 3) AT7703

Retaining Ring AT7704



Brass Skimmer Adaptor
base for x lens AT8905X-BR

Stainless Steel Skimmer
Adaptor base for x lens AT8905X-SS



Common Accessories

Elegra Argon Humidifier

Elegra Dual Argon Humidifier 70-803-1273



Elegra Stand 70-803-1581



Guardian In-Line Filters

Guardian DC in-line non-return
gas filter 70-803-1942

Guardian in-line sample filter 70-803-1108

Eluo Adaptor for Inline Filter 70-803-1160



Common Accessories

(continued)

Trident Internal Standard Kits

Trident CT Standard Kit 60-703-1179

Standard Kit for HF 60-808-1150

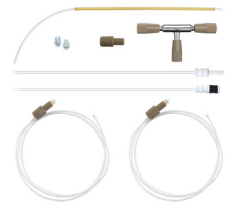

Magnifier Inspection Tool 70-803-1923



Autosampler Probes (See page 20-21 for complete list of probes)

For Agilent I-AS

PTFE Encapsulated Carbon
Fibre Probe 0.25mm ID 60-703-1010

PTFE Encapsulated Carbon
Fibre Probe 0.3mm ID 60-703-1009



For Cetac ASX-200/500/800 Series

Guardian Probe 0.75mm
Probe Connecting Line (Red) 70-803-1803

Polyimide sheathed Autosampler
Probe 0.5mm ID 60-808-1186L

PTFE Encapsulated Carbon
Fibre Probe 0.5mm ID 70-803-0784

PTFE Encapsulated Carbon
Fibre Probe 0.75mm ID 70-803-1443

PTFE Encapsulated Carbon
Fibre Probe 1.0mm ID 70-803-0793



For SPS 3/SPS 4

Guardian Probe 0.75mm
Probe Connecting Line (Red) 70-803-1957

PTFE Encapsulated Carbon
Fibre Probe 0.75mm ID 70-803-0908

PTFE Encapsulated Carbon
Fibre Probe 1.0mm ID 70-803-0853

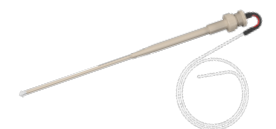

Glass DC Nebulizers

SeaSpray

400µL/min uptake A13-1-USS04

MicroMist

400µL/min uptake A13-1-UM04

200µL/min uptake A13-1-UM02

100µL/min uptake A13-1-UM01

50µL/min uptake A13-1-UM005

Conikal

1mL/min uptake A13-1-UC1



Quartz DC Nebulizers

SeaSpray

1mL/min uptake A13-1-QSS1



DC Nebulizers for HF

OpalMist

400µL/min uptake A13-1-PFA04

200µL/min uptake A13-1-PFA02

100µL/min uptake A13-1-PFA01

50µL/min uptake A13-1-PFA005



DC Nebulizers for HE-SIS

MicroMist HE

200µL/min uptake C13-1-UFT02

200µL/min uptake E13-1-UFT02



IsoMist XR

Programmable Temperature Cyclonic Spray Chamber

IsoMist XR Kit KT-1103-XR

Comprises:

Glass Twister Spray Chamber 21-809-3186

Assembly (ROL) 20-809-5176

Mount 21-809-3765

Make-up Gas Adaptor 21-809-4024

Metal Ball Joint Clip JC-13

UniFit Connector (PKT. 3) UFT-2-86



Peltier Controlled Cyclonic Spray Chambers

For Agilent 7800

Glass Spray Chamber KT-1206

Quartz Spray Chamber KT-1206Q

PFA Spray Chamber KT-1206P



For Agilent 7850

Glass Spray Chamber KT-1116

Quartz Spray Chamber KT-1116Q

PFA Spray Chamber KT-1116P



Spray Chambers

High Efficiency Sample Introduction System

HE-SIS for Agilent ICP-MS KT-1155



*Twister

20mL Cyclonic with Aux. 20-809-2574HE

*Requires adaptor KT-1104.



Spray Chambers for HF

*Tracey PFA44

44ml Cyclonic with Aux. 20-809-2578

Spray Chamber Adaptor KT-1104

*Requires adaptor KT-1104.



Torches

Quartz Torches

with 1.0mm Injector	30-807-0558
with 1.5mm Injector	30-807-0557
with 2.0mm Injector	30-807-3608
with 2.5mm Injector	30-807-0556

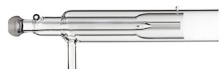

Torch Options

Quartz Torch Bonnet	31-808-2577
Quartz Connector with Dilution Port	31-808-3217
Quartz Connector with 45deg Dilution Port	31-808-3280
Straight Quartz Connector	31-808-3288
Clamp (PKT 2)	70-803-0846



Semi-Demountable Torch

with 2.4mm Quartz Injector	30-808-3853
----------------------------	-------------



Torch Options

Semi-Demountable Torch body	31-808-3857
1.0mm Tapered Quartz Injector	31-808-4172
1.5mm Tapered Quartz Injector	31-808-4173
2.4mm Tapered Quartz Injector	31-808-4168
1.0 mm Tapered Alumina Injector	31-808-4169
1.5 mm Tapered Alumina Injector	31-808-4170
2.4mm Tapered Alumina Injector	31-808-3855
2.4mm Sapphire Capillary Injector	31-808-4159
PEEK Injector Adaptor	31-808-4478



Viton O-rings for FDT/SDT ball joints (PKT 10)	70-V-011
--	----------



RF Coils

Copper	70-900-7800C
--------	--------------



Silver	70-900-7800S
--------	--------------



Gold	70-900-7800G
------	--------------



RF Coil Installation Kit	70-900-7500T
--------------------------	--------------



Cones

Sampler Cones

Nickel Sampler	AT7701-Ni
----------------	-----------

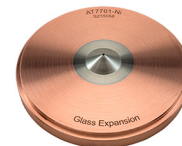

Nickel Sampler with Nickel plated base	AT7701-Ni/Ni
--	--------------

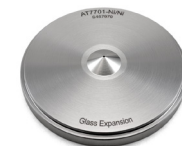

Aluminium Sampler	AT7701-Al
-------------------	-----------



Platinum Sampler	AT7706-Pt
------------------	-----------



Platinum Sampler (18 mm Insert)	AT7706A-Pt
---------------------------------	------------



Platinum Sampler with Nickel plated base	AT7706-Pt/NiP
--	---------------

Cones

(continued)

Sampler Cones (continued)

Platinum Sampler with solid Nickel base	AT7706-Pt/Ni
Platinum Sampler (15mm insert) with Nickel base	AT7706B-Pt/Ni
Platinum Sampler with Nickel plated base (Extended Life)	AT7706L-Pt/NiP



Skimmer Cones

Nickel Skimmer for x-lens	AT7702X-Ni
Aluminium Skimmer for x-lens	AT7702X-Al



Platinum Skimmer for x-lens	AT7708X-Pt
-----------------------------	------------



Platinum Skimmer with Nickel base for x-lens	AT7708X-Pt/Ni
--	---------------



Cone Options

Skimmer Cone Guard	70-803-1008
Long Life Pt Shield Plate	AT5004
Graphite Gasket (PKT 3)	AT7703
Retaining Ring	AT7704



Common Accessories

Elegra Argon Humidifier

Elegra Dual Argon Humidifier	70-803-1273
Elegra Stand	70-803-1581



Guardian In-Line Filters

Guardian DC in-line non-return gas filter	70-803-1942
Guardian in-line sample filter	70-803-1108
Eluo Adaptor for Inline Filter	70-803-1160



Common Accessories

(continued)

Trident Internal Standard Kits

Trident CT Standard Kit	60-703-1179
Standard Kit for HF	60-808-1150

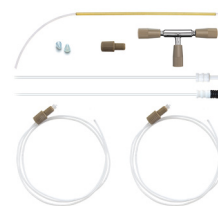

Magnifier Inspection Tool 70-803-1923



Autosampler Probes (See page 20-21 for complete list of probes)

For Agilent I-AS

PTFE Encapsulated Carbon Fibre Probe 0.25mm ID	60-703-1010
PTFE Encapsulated Carbon Fibre Probe 0.3mm ID	60-703-1009



For Cetac ASX-200/500/800 Series

Guardian Probe 0.75mm	
Probe Connecting Line (Red)	70-803-1803
Polyimide sheathed Autosampler Probe 0.5mm ID	60-808-1186L
PTFE Encapsulated Carbon Fibre Probe 0.5mm ID	70-803-0784
PTFE Encapsulated Carbon Fibre Probe 0.75mm ID	70-803-1443
PTFE Encapsulated Carbon Fibre Probe 1.0mm ID	70-803-0793



For SPS 3/SPS 4

Guardian Probe 0.75mm	
Probe Connecting Line (Red)	70-803-1957
PTFE Encapsulated Carbon Fibre Probe 0.75mm ID	70-803-0908
PTFE Encapsulated Carbon Fibre Probe 1.0mm ID	70-803-0853



Glass DC Nebulizers

SeaSpray

400µL/min uptake A13-1-USS04

MicroMist

400µL/min uptake A13-1-UM04
 200µL/min uptake A13-1-UM02
 100µL/min uptake A13-1-UM01
 50µL/min uptake A13-1-UM005



Conikal

1mL/min uptake A13-1-UC1

Quartz DC Nebulizers

SeaSpray

1mL/min uptake A13-1-QSS1



DC Nebulizers for HF

OpalMist

400µL/min uptake A13-1-PFA04
 200µL/min uptake A13-1-PFA02
 100µL/min uptake A13-1-PFA01
 50µL/min uptake A13-1-PFA005



DC Nebulizers for HE-SIS

MicroMist HE

200µL/min uptake C13-1-UFT02
 200µL/min uptake E13-1-UFT02



IsoMist XR

Programmable Temperature Cyclonic Spray Chamber

IsoMist XR Kit KT-1103-XR

Comprises:

Glass Twister Spray Chamber 21-809-3186
 Assembly (ROL) 20-809-5176
 Mount 21-809-3765
 Make-up Gas Adaptor 21-809-4024
 Metal Ball Joint Clip JC-13
 UniFit Connector (PKT. 3) UFT-2-86



Peltier Controlled Cyclonic Spray Chambers

Glass Spray Chamber KT-1206
 Quartz Spray Chamber KT-1206Q
 PFA Spray Chamber KT-1206P



Spray Chambers

High Efficiency Sample Introduction System

HE-SIS for Agilent ICP-MS KT-1155



*Twister

50mL Cyclonic with Aux. 20-809-2574HE

*Requires adaptor KT-1104.



Spray Chambers for HF

*Tracey PFA44

44ml Cyclonic with Aux. 20-809-2578
 Spray Chamber Adaptor KT-1104

*Requires adaptor KT-1104.



Torches

Quartz Torches

with 1.0mm Injector	30-807-0558
with 1.5mm Injector	30-807-0557
with 2.0mm Injector	30-807-3608
with 2.5mm Injector	30-807-0556

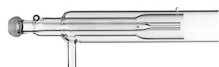

Torch Options

Quartz Torch Bonnet	31-808-2577
Quartz Connector with Dilution Port	31-808-3217
Quartz Connector with 45deg Dilution Port	31-808-3280
Straight Quartz Connector	31-808-3288
Clamp (PKT 2)	70-803-0846



Semi-Demountable Torch

with 2.4mm Quartz Injector	30-808-3853
----------------------------	-------------



Torch Options

Semi-Demountable Torch body	31-808-3857
1.0mm Tapered Quartz Injector	31-808-4172
1.5mm Tapered Quartz Injector	31-808-4173
2.4mm Tapered Quartz Injector	31-808-4168
1.0 mm Tapered Alumina Injector	31-808-4169
1.5 mm Tapered Alumina Injector	31-808-4170
2.4mm Tapered Alumina Injector	31-808-3855
2.4mm Sapphire Capillary Injector	31-808-4159
PEEK Injector Adaptor	31-808-4478



Viton O-rings for FDT/SDT ball joints (PKT 10)	70-V-011
--	----------



RF Coils

Copper	70-900-7700C
--------	--------------



Silver	70-900-7700S
--------	--------------



Gold	70-900-7700G
------	--------------



RF Coil Installation Kit	70-900-7500T
--------------------------	--------------



Cones

Sampler Cones

Nickel Sampler	AT7701-Ni
----------------	-----------



Nickel Sampler with Nickel plated base	AT7701-Ni/Ni
--	--------------

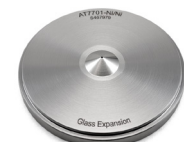

Aluminium Sampler	AT7701-Al
-------------------	-----------



Platinum Sampler	AT7706-Pt
------------------	-----------

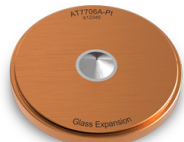

Platinum Sampler (18 mm Insert)	AT7706A-Pt
---------------------------------	------------



Platinum Sampler with Nickel plated base	AT7706-Pt/NiP
--	---------------

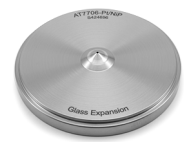

Cones

(continued)

Sampler Cones (continued)

Platinum Sampler with solid Nickel base	AT7706-Pt/Ni
Platinum Sampler (15mm insert) with Nickel base	AT7706B-Pt/Ni
Platinum Sampler with Nickel plated base (Extended Life)	AT7706L-Pt/NiP

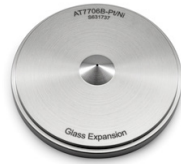

Skimmer Cones

Nickel Skimmer for x-lens	AT7702X-Ni
Aluminium Skimmer for x-lens	AT7702X-Al



Platinum Skimmer for x-lens	AT7708X-Pt
-----------------------------	------------



Platinum Skimmer with Nickel base for x-lens	AT7708X-Pt/Ni
--	---------------

Nickel Skimmer for s-lens	AT7702S-Ni
---------------------------	------------

Platinum Skimmer for s-lens	AT7708S-Pt
-----------------------------	------------

Platinum Skimmer with Nickel base for s-lens	AT7708S-Pt/Ni
--	---------------



Cone Options

Skimmer Cone Guard for x-lens	70-803-1008
Skimmer Cone Guard for s-lens	70-803-1004
Long Life Pt Shield Plate	AT5004
Retaining Ring	AT7704
Graphite Gasket (PKT 3)	AT7703



Common Accessories

Elegra Argon Humidifier

Elegra Dual Argon Humidifier	70-803-1273
Elegra Stand	70-803-1581



Common Accessories

(continued)

Guardian In-Line Filters

Guardian DC in-line non-return gas filter	70-803-1942
Guardian in-line sample filter	70-803-1108
Eluo Adaptor for Inline Filter	70-803-1160



Trident Internal Standard Kits

Trident CT Standard Kit	60-703-1179
Standard Kit for HF	60-808-1150

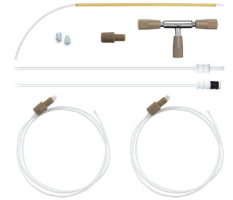

Magnifier Inspection Tool 70-803-1923



Autosampler Probes (See page 20-21 for complete list of probes)

For Agilent I-AS

PTFE Encapsulated Carbon Fibre Probe 0.25mm ID	60-703-1010
PTFE Encapsulated Carbon Fibre Probe 0.3mm ID	60-703-1009



For Cetac ASX-200/500/800 Series

Guardian Probe 0.75mm Probe Connecting Line (Red)	70-803-1803
Polyimide sheathed Autosampler Probe 0.5mm ID	60-808-1186L
PTFE Encapsulated Carbon Fibre Probe 0.5mm ID	70-803-0784
PTFE Encapsulated Carbon Fibre Probe 0.75mm ID	70-803-1443
PTFE Encapsulated Carbon Fibre Probe 1.0mm ID	70-803-0793



For SPS 3/SPS 4

Guardian Probe 0.75mm Probe Connecting Line (Red)	70-803-1957
PTFE Encapsulated Carbon Fibre Probe 0.75mm ID	70-803-0908
PTFE Encapsulated Carbon Fibre Probe 1.0mm ID	70-803-0853

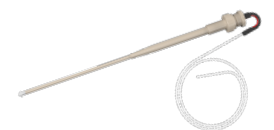

Glass DC Nebulizers

SeaSpray

2mL/min uptake	A13-07-USS2
400µL/min uptake	A13-07-USS04

MicroMist

400µL/min uptake	A13-07-UM04
200µL/min uptake	A13-07-UM02

Conikal

2mL/min uptake	A13-07-UC2
1mL/min uptake	A13-07-UC1

Slurry

4mL/min uptake	A13-07-US6
----------------	------------



Spray Chambers

Twister

50mL Cyclonic	20-809-9199HE
---------------	---------------



Tracey

50mL Cyclonic	20-808-8882HE
---------------	---------------



DC Nebulizers for HF

DuraMist

1mL/min uptake	A13-07-DM1
400µL/min uptake	A13-07-DM04



OpalMist

2mL/min uptake	A13-07-PFA2
600µL/min uptake	A13-07-PFA06
200µL/min uptake	A13-07-PFA02
100µL/min uptake	A13-07-PFA01
50µL/min uptake	A13-07-PFA005



VeeSpray

0.6 - 3mL/min uptake	A13-07-CV6
----------------------	------------



HydraMist Simultaneous Cold Vapor/ Pneumatic Nebulization Spray Chamber

Hydride Kit	KT-1157
-------------	---------



Spray Chambers for HF

Twister TFE Spray Chamber

50mL Cyclonic	20-809-3452
---------------	-------------



Tracey TFE Spray Chamber

50mL Cyclonic	20-809-2507
---------------	-------------



IsoMist XR

Programmable Temperature Cyclonic Spray Chamber

IsoMist XR Kit	KT-1137-XR
----------------	------------

Comprises:

Glass Twister Spray Chamber	21-809-3186
Assembly (ROL)	20-809-5176
PuraFlex Transfer Tube	21-809-4038
Metal Ball Joint Clip	JC-13
UniFit Right Angle Connector (PKT 3)	GAZ-04-90



Torches

D-Torch

SVDV/VDV 30-808-3560 



Comprises:

- Base and Inner Tube 31-808-3568
- Quartz Outer Tube 31-808-3570
- Retaining Ring 31-808-3566
- Injector Ferrule 31-808-2962
- Injector Adaptor 31-808-3578
- RV 30-808-3590

Comprises:

- Base and Inner Tube 31-808-3568
- Quartz Outer Tube 31-808-3582
- Retaining Ring 31-808-3566
- Injector Ferrule 31-808-2962
- Injector Adaptor 31-808-3578

D-Torch Options:

- Ceramic Outer Tube for SVDV/VDV 31-808-3580 
- Ceramic Outer Tube for RV 31-808-3586
- Quartz Outer Tube for SVDV/VDV 31-808-3570 
- Quartz Outer Tube for RV 31-808-3582
- O-ring Kit 70-803-1500
- Ignition Enhancer 31-808-4020



Quartz Torch

- SVDV/VDV 31-808-3557 
- RV 31-808-3556
- Retaining Ring 31-808-3563 
- Pre-Optic Window Axial 70-803-1968
- Pre-Optic Window Radial 70-803-1969
- O-ring for Window Axial (PKT 5) 70-803-2794 
- Pre-optics cone 70-803-2751

Torches

(continued)

Tapered Injectors

- Quartz Injector 0.8mm 31-808-3738 
- Quartz Injector 1.4mm 31-808-3583
- Quartz Injector 1.8mm 31-808-3576
- Quartz Injector 2.4mm 31-808-3584
- Alumina Injector 1.5mm 31-808-3725 
- Alumina Injector 1.8mm 31-808-3585
- Alumina Injector 2.4mm 31-808-3722

Injectors for Agilent FDT

- Quartz Injector 0.8mm 31-808-4357
- Quartz Injector 1.4mm 31-808-4354
- Quartz Injector 1.8mm 31-808-4355 
- Quartz Injector 2.4mm 31-808-4356
- Alumina Injector 1.8mm 31-808-4358

RF Coils

- Silver 70-900-5100S
- Gold 70-900-5100G
- Copper 70-900-5100C
- RF Coil Installation Kit 70-900-5100T 

Common Accessories

Elegra Argon Humidifier

Elegra Argon Humidifier 70-803-1268



Guardian In-Line Filters

Guardian DC in-line non-return gas filter 70-803-1942

Guardian in-line sample filter 70-803-1108

Eluo Adaptor for Inline Filter 70-803-1160



Trident Internal Standard Kits

Trident CT Standard Kit 60-703-1179

Standard Kit for HF 60-808-1150

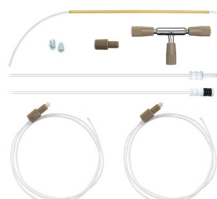

Magnifier Inspection Tool 70-803-1923



Autosampler Probes (See page 20-21 for complete list of probes)

For Cetac ASX-200/500/800 Series

Guardian Probe 0.75mm
Probe Connecting Line (Red) 70-803-1803

Polyimide sheathed Autosampler Probe
0.5mm ID 60-808-1186L

PTFE Encapsulated Carbon Fibre Probe
0.5mm ID 70-803-0784

PTFE Encapsulated Carbon Fibre Probe
0.75mm ID 70-803-1443

PTFE Encapsulated Carbon Fibre Probe
1.0mm ID 70-803-0793



For SPS 3/SPS 4

Guardian Probe 0.75mm
Probe Connecting Line (Red) 70-803-1957

PTFE Encapsulated Carbon Fibre Probe
0.75mm ID 70-803-0908

PTFE Encapsulated Carbon Fibre Probe
1.0mm ID 70-803-0853



Glass DC Nebulizers

SeaSpray

2mL/min uptake	A13-07-USS2
1mL/min uptake	A13-05-USS1

MicroMist

400µL/min uptake	A13-05-UM04
------------------	-------------

Conikal

1mL/min uptake	A13-05-UC1
----------------	------------

Slurry

4mL/min uptake	A13-07-US6
----------------	------------



DC Nebulizers for HF

DuraMist

1mL/min uptake	A13-05-DM1
400µL/min uptake	A13-05-DM04



VeeSpray

0.6 - 3mL/min uptake	A13-07-CV6
----------------------	------------



IsoMist XR

Programmable Temperature Cyclonic Spray Chamber

IsoMist XR Kit	KT-1135-XR
----------------	------------

Comprises:

Glass Twister Spray Chamber Assembly (LOL)	21-809-3185
PuraFlex Transfer Tube	21-809-2962
Metal Ball Joint Clip	JC-13
UniFit Right Angle Connector (PKT 3)	GAZ-04-90



Spray Chambers

HydraMist Simultaneous Cold Vapor/ Pneumatic Nebulization Spray Chamber

Hydride Kit	KT-1157
-------------	---------



Twister

50mL Cyclonic	20-809-0222HE
---------------	---------------



Tracey

50mL Cyclonic	20-808-8882HE
---------------	---------------



Cinnabar

20mL Cyclonic	20-809-0164HE
---------------	---------------



Spray Chambers for HF

Tracey TFE Spray Chamber

50mL Cyclonic	20-809-2506
---------------	-------------



PuraFlex Transfer Tube

21-809-2962



Torches

Fully Demountable Torch

Torch Body 31-808-8896



Fully Demountable Torch Options:

Quartz Outer Tube 31-808-8020



Syalon Outer Tube 31-808-0023

Quartz Inner Tube 31-808-8145



Alumina Inner Tube 31-808-0017

Ball Joint Adaptor 31-807-0018

Torch Bonnet - Large 31-808-3607

Radial Purge Window 31-808-8098

O-rings for Glass Body (PKT 10) 70-4X2.5V75

Viton O-rings for FDT/SDT Ball Joints (PKT 10) 70-V-011

PTFE Coated Viton O-rings for Cyclonics/Nebulizer Seal (PKT 10) VT-009

EzyGlide Cloth 70-EZG-CLOTH



Tapered Injectors

Quartz Injector 1.0mm 31-808-0009



Quartz Injector 2.0mm 31-808-0008

Alumina Injector 2.0mm 31-808-0027



Common Accessories

Elegra Argon Humidifier

Elegra Argon Humidifier 70-803-1266



Guardian In-Line Filters

Guardian in-line sample filter 70-803-1108

Eluo Adaptor for Inline Filter 70-803-1160



Common Accessories

(continued)

Trident Internal Standard Kits

Trident CT Standard Kit 60-703-1179

Standard Kit for HF 60-808-1150

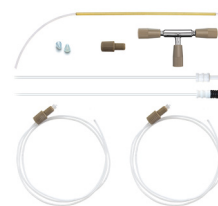

Magnifier Inspection Tool 70-803-1923



Autosampler Probes (See page 20-21 for complete list of probes)

For Cetac ASX-200/500/800 Series

Guardian Probe 0.75mm

Probe Connecting Line (Red) 70-803-1803

Polyimide sheathed Autosampler Probe 0.5mm ID 60-808-1186L

PTFE Encapsulated Carbon Fibre Probe 0.5mm ID 70-803-0784

PTFE Encapsulated Carbon Fibre Probe 0.75mm ID 70-803-1443

PTFE Encapsulated Carbon Fibre Probe 1.0mm ID 70-803-0793

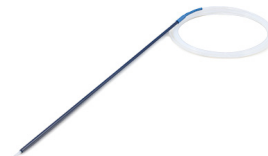

For SPS 3/SPS 4

Guardian Probe 0.75mm Probe Connecting Line (Red) 70-803-1957

PTFE Encapsulated Carbon Fibre Probe 0.75mm ID 70-803-0908

PTFE Encapsulated Carbon Fibre Probe 1.0mm ID 70-803-0853



Glass DC Nebulizers

SeaSpray

400µL/min uptake A52-1-USS04

MicroMist

400µL/min uptake A52-1-UM04

200µL/min uptake A52-1-UM02

100µL/min uptake A52-1-UM01



DC Nebulizers for HF

OpalMist

50µL/min uptake A52-1-PFA005



DC Nebulizers for HE-SIS

MicroMist HE

200µL/min uptake C52-1-UFT02



Spray Chambers

High Efficiency Sample Introduction System

HE-SIS for Nu Vitesse KT-1219



Twister

50mL Cyclonic 20-809-0495HE



Torches

Quartz Torch

with 1.5mm Injector 30-807-0560



Viton O-rings for FDT/SDT

ball joints (PKT 10) 70-V-011



Cones

Sampler Cones

Nickel Sampler Version A, Wet Plasma NU1011A-Ni



Nickel Dry Sampler with Copper Core NU1011B-Ni



Skimmer Cones

Nickel Skimmer Version A, Wet Plasma NU1004A-Ni



Nickel Dry Skimmer NU1014B-Ni

Common Accessories

Guardian In-Line Filters

Guardian DC in-line non-return gas filter 70-803-1942



Trident Internal Standard Kits

Trident CT Standard Kit 60-703-1179

Standard Kit for HF 60-808-1150

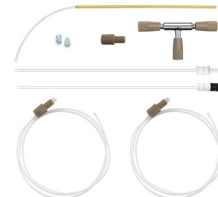

Magnifier Inspection Tool

70-803-1923



Glass DC Nebulizers

SeaSpray

2mL/min uptake	A23-1-USS2
1mL/min uptake	A23-1-USS1
400µL/min uptake	A23-1-USS04

MicroMist

400µL/min uptake	A23-1-UM04
200µL/min uptake	A23-1-UM02
100µL/min uptake	A23-1-UM01
50µL/min uptake	A23-1-UM005



Quartz DC Nebulizers

SeaSpray

1mL/min uptake	A23-1-QSS1
----------------	------------



DC Nebulizers for HF

OpalMist

400µL/min uptake	A23-1-PFA04
200µL/min uptake	A23-1-PFA02
100µL/min uptake	A23-1-PFA01
50µL/min uptake	A23-1-PFA005



DC Nebulizers for HE-SIS

MicroMist HE

200µL/min uptake	C23-1-UFT02
------------------	-------------



Spray Chambers

Twister

50mL Cyclonic	20-809-4417HE
50mL Cyclonic	20-809-4560
With Matrix Port	



Tracey

50mL Cyclonic	20-809-4419HE
---------------	---------------



Spray Chambers

Cinnabar

20mL Cyclonic	20-809-4480HE
---------------	---------------



High Efficiency Sample Introduction System

HE-SIS for PerkinElmer NexION	KT-1184
-------------------------------	---------

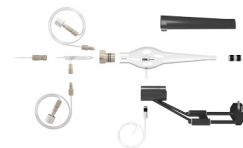

Torches

D-Torch

30-808-3927

Comprises:

Base and Inner Tube	31-808-3928
Quartz Outer Tube	31-808-3942
Retaining Ring	31-808-2818
Injector Adaptor	31-808-3980
Injector Ferrule	31-808-2962
Fastener Assembly	31-808-4130
Viton O-rings (PKT 10)	70-V-011
PTFE Coated Viton O-rings (PKT 10)	70-VT-012



Quartz Injectors

Tapered 1.0mm	31-808-3423
Tapered 1.8mm	31-808-4005
Tapered 2.0mm	31-808-4006
Tapered 2.5mm	31-808-3302



HF Resistant Injectors

Tapered Alumina 2.4mm	31-808-3205
Sapphire 2.4mm	31-808-3378



Cones

Sampler Cones

Nickel Sampler PE3011-Ni



Platinum Sampler PE3013-Pt

Platinum Sampler (18mm) PE3013A-Pt

Platinum Sampler (12mm) PE3013C-Pt

Platinum Sampler PE3013-Pt

Boron Free PE3013-Pt-BF



Skimmer Cones

Nickel Skimmer PE4212-Ni

Platinum Skimmer PE4214-Pt

Nickel Hyper Skimmer PE4015-Ni

All Nickel Hyper Skimmer PE4016-Ni



O-ring for NexION Hyper Skimmer Cone (pack of 5)

PE5125



ConeGuard Thread Protectors

Sampler Cone Guard For NexION 70-803-1024



Gasket for Sampler Cone (pack of 5)

PE5111



Common Accessories

Elegra Argon Humidifier

Elegra Dual Argon Humidifier 70-803-1473



Guardian In-Line Filters

Guardian DC in-line non-return gas filter 70-803-1942

Guardian in-line sample filter 70-803-1108

Eluo Adaptor for Inline Filter 70-803-1160



Trident Internal Standard Kits

Trident CT Standard Kit 60-703-1179

Standard Kit for HF 60-808-1150

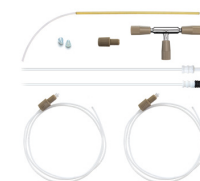

Magnifier Inspection Tool 70-803-1923



Autosampler Probes (See page 20-21 for complete list of probes)

Suitable for Cetac ASX-200/500/800 Series and PerkinElmer S20 Series

Guardian Probe 0.75mm Probe Connecting Line (Red) 70-803-1803

*(suitable for Cetac only)



Guardian Probe 0.75mm Probe Connecting Line (Red) 70-803-2097

*(suitable for PerkinElmer S20 Series only)



Polyimide sheathed Autosampler Probe 0.5mm ID 60-808-1186L

PTFE Encapsulated Carbon Fibre Probe 0.5mm ID 70-803-0784

PTFE Encapsulated Carbon Fibre Probe 0.75mm ID 70-803-1443

PTFE Encapsulated Carbon Fibre Probe 1.0mm ID 70-803-0793



Glass DC Nebulizers

SeaSpray

2mL/min uptake	A23-1-USS2
1mL/min uptake	A23-1-USS1
400µL/min uptake	A23-1-USS04

MicroMist

400µL/min uptake	A23-1-UM04
200µL/min uptake	A23-1-UM02
100µL/min uptake	A23-1-UM01
50µL/min uptake	A23-1-UM005



Quartz DC Nebulizers

SeaSpray

1mL/min uptake	A23-1-QSS1
----------------	------------



DC Nebulizers for HF

OpalMist

400µL/min uptake	A23-1-PFA04
200µL/min uptake	A23-1-PFA02
100µL/min uptake	A23-1-PFA01
50µL/min uptake	A23-1-PFA005



DC Nebulizers for HE-SIS

MicroMist HE

200µL/min uptake	C23-1-UFT02
------------------	-------------



Spray Chambers

Twister

50mL Cyclonic	20-809-4417HE
50mL Cyclonic	20-809-4560
With Matrix Port	



Tracey

50mL Cyclonic	20-809-4419HE
---------------	---------------



Spray Chambers

Cinnabar

20mL Cyclonic	20-809-4480HE
---------------	---------------



High Efficiency Sample Introduction System

HE-SIS for PerkinElmer NexION	KT-1184
-------------------------------	---------

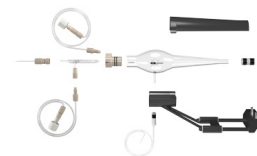

Torches

D-Torch

30-808-3927

Comprises:

Base and Inner Tube	31-808-3928
Quartz Outer Tube	31-808-3942
Retaining Ring	31-808-2818
Injector Adaptor	31-808-3980
Injector Ferrule	31-808-2962
Fastener Assembly	31-808-4130
Viton O-rings (PKT 10)	70-V-011
PTFE Coated Viton O-rings (PKT 10)	70-VT-012



Quartz Injectors

Tapered 1.0mm	31-808-3423
Tapered 1.8mm	31-808-4005
Tapered 2.0mm	31-808-4006
Tapered 2.5mm	31-808-3302



HF Resistant Injectors

Tapered Alumina 2.4mm	31-808-3205
Sapphire 2.4mm	31-808-3378



Cones

Sampler Cones

Nickel Sampler PE3011-Ni



Platinum Sampler PE3013-Pt

Platinum Sampler (18mm) PE3013A-Pt

Platinum Sampler (12mm) PE3013C-Pt

Platinum Sampler Boron Free PE3013-Pt-BF



Skimmer Cones

Nickel Skimmer PE4012-Ni

Platinum Skimmer PE4014-Pt

Nickel Hyper Skimmer PE4015-Ni

All Nickel Hyper Skimmer PE4016-Ni



O-ring for NexION Hyper Skimmer Cone (pack of 5)

PE5125



ConeGuard Thread Protectors

Sampler Cone Guard For NexION 70-803-1024



Gasket for Sampler Cone (pack of 5)

PE5111



Common Accessories

Elegra Argon Humidifier

Elegra Dual Argon Humidifier 70-803-1473



Guardian In-Line Filters

Guardian DC in-line non-return gas filter 70-803-1942

Guardian in-line sample filter 70-803-1108

Eluo Adaptor for Inline Filter 70-803-1160



Trident Internal Standard Kits

Trident CT Standard Kit 60-703-1179

Standard Kit for HF 60-808-1150

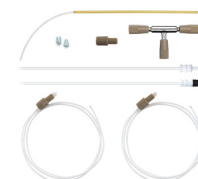

Magnifier Inspection Tool 70-803-1923



Autosampler Probes (See page 20-21 for complete list of probes)

Suitable for Cetac ASX-200/500/800 Series and PerkinElmer S20 Series

Guardian Probe 0.75mm Probe Connecting Line (Red) 70-803-1803
*(suitable for Cetac only)



Guardian Probe 0.75mm Probe Connecting Line (Red) 70-803-2097
*(suitable for PerkinElmer S20 Series only)



Polyimide sheathed Autosampler Probe 0.5mm ID 60-808-1186L

PTFE Encapsulated Carbon Fibre Probe 0.5mm ID 70-803-0784

PTFE Encapsulated Carbon Fibre Probe 0.75mm ID 70-803-1443

PTFE Encapsulated Carbon Fibre Probe 1.0mm ID 70-803-0793



Glass DC Nebulizers

SeaSpray

2mL/min uptake	A23-1-USS2
1mL/min uptake	A23-1-USS1
400µL/min uptake	A23-1-USS04

MicroMist

400µL/min uptake	A23-1-UM04
200µL/min uptake	A23-1-UM02
100µL/min uptake	A23-1-UM01
50µL/min uptake	A23-1-UM005



Quartz DC Nebulizers

SeaSpray

1mL/min uptake	A23-1-QSS1
----------------	------------



DC Nebulizers for HF

OpalMist

400µL/min uptake	A23-1-PFA04
200µL/min uptake	A23-1-PFA02
100µL/min uptake	A23-1-PFA01
50µL/min uptake	A23-1-PFA005



DC Nebulizers for HE-SIS

MicroMist HE

200µL/min uptake	C23-1-UFT02
------------------	-------------



Spray Chambers

Twister

50mL Cyclonic	20-809-4417HE
50mL Cyclonic With Matrix Port	20-809-4560



Tracey

50mL Cyclonic	20-809-4419HE
---------------	---------------



Spray Chambers

Cinnabar

20mL Cyclonic	20-809-4480HE
---------------	---------------



High Efficiency Sample Introduction System

HE-SIS for PerkinElmer NexION	KT-1184
-------------------------------	---------

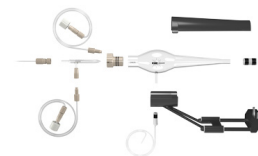

Torches

D-Torch

30-808-3927



Comprises:

Base and Inner Tube	31-808-3928
Quartz Outer Tube	31-808-3942
Retaining Ring	31-808-2818
Injector Adaptor	31-808-3980
Injector Ferrule	31-808-2962
Fastener Assembly	31-808-4130
Viton O-rings (PKT 10)	70-V-011
PTFE Coated Viton O-rings (PKT 10)	70-VT-012

Quartz Injectors

Tapered 1.0mm	31-808-3423
Tapered 1.8mm	31-808-4005
Tapered 2.0mm	31-808-4006
Tapered 2.5mm	31-808-3302



HF Resistant Injectors

Tapered Alumina 2.4mm	31-808-3205
Sapphire 2.4mm	31-808-3378



Cones

Sampler Cones

Nickel Sampler PE3011-Ni



Aluminium Sampler PE3011-AI

Platinum Sampler PE3013-Pt

Platinum Sampler (18mm) PE3013A-Pt

Platinum Sampler (18mm) PE3013C-Pt

Platinum Sampler Boron Free PE3013-Pt-BF



Skimmer Cones

Nickel Skimmer PE3012-Ni



Aluminium Skimmer PE3012-AI

Platinum Skimmer PE3014-Pt

Platinum Skimmer Boron Free PE3014-Pt-BF

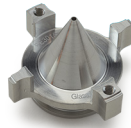

Aluminium Hyper Skimmer PE3015-AI

Nickel Hyper Skimmer PE3015-Ni

Platinum Hyper Skimmer PE3015-Pt/Ni

O-ring for NexION Hyper Skimmer Cone (pack of 5) PE5115



Screw for NexION Hyper Skimmer Cone (pack of 2) PE5116



ConeGuard Thread Protectors

Sampler Cone Guard For NexION 70-803-1024

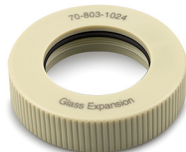

Skimmer Cone Guard For NexION 70-803-1026



Gasket for Sampler Cone (pack of 5) PE5111



Common Accessories

Elegra Argon Humidifier

Elegra Dual Argon Humidifier 70-803-1473



Guardian In-Line Filters

Guardian DC in-line non-return gas filter 70-803-1942

Guardian in-line sample filter 70-803-1108

Eluo Adaptor for Inline Filter 70-803-1160



Trident Internal Standard Kits

Trident CT Standard Kit 60-703-1179

Standard Kit for HF 60-808-1150

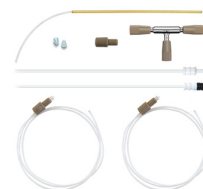

Magnifier Inspection Tool 70-803-1923



Autosampler Probes (See page 20-21 for complete list of probes)

Suitable for Cetac ASX-200/500/800 Series and PerkinElmer S20 Series

Guardian Probe 0.75mm
 Probe Connecting Line (Red) 70-803-1803
 *(suitable for Cetac only)



Guardian Probe 0.75mm
 Probe Connecting Line (Red) 70-803-2097
 *(suitable for PerkinElmer S20 Series only)



Polyimide sheathed Autosampler
 Probe 0.5mm ID 60-808-1186L

PTFE Encapsulated Carbon Fibre
 Probe 0.5mm ID 70-803-0784

PTFE Encapsulated Carbon Fibre
 Probe 0.75mm ID 70-803-1443

PTFE Encapsulated Carbon Fibre
 Probe 1.0mm ID 70-803-0793



Glass DC Nebulizers

SeaSpray

1mL/min uptake	A22-1-USS1
400µL/min uptake	A22-1-USS04

MicroMist

400µL/min uptake	A22-1-UM04
200µL/min uptake	A22-1-UM02
100µL/min uptake	A22-1-UM01



DC Nebulizers for HF

OpalMist

400µL/min uptake	A22-1-PFA04
200µL/min uptake	A22-1-PFA02
100µL/min uptake	A22-1-PFA01
50µL/min uptake	A22-1-PFA005



DC Nebulizers for HE-SIS

MicroMist HE

200µL/min uptake	C22-1-UFT02
------------------	-------------



Spray Chambers

Twister

50mL Cyclonic (2.4mm Aux. Port) 90deg Screw Mount	20-809-3854HE
---	---------------



Twister

50mL Cyclonic with Screw Mount	20-809-3892HE
-----------------------------------	---------------



Spray Chambers for HF

Tracey PFA44

44mL Cyclonic	20-809-3713
---------------	-------------



High Efficiency Sample Introduction System

HE-SIS for PerkinElmer NexION 300/350	KT-1204
---------------------------------------	---------



Torches

D-Torch

30-807-0540

Comprises:

Base and Inner Tube	31-808-2847
Quartz Outer Tube	31-808-2848
Retaining Ring	31-808-2818



D-Torch for HF

30-808-2937

Comprises:

Base and Inner Tube	31-808-2847
Ceramic Outer Tube	31-808-2849
Retaining Ring	31-808-2818



D-Torch Options:

Quartz Outer Tube	31-808-2848
Ceramic Outer Tube	31-808-2849

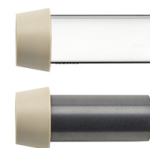

Torches

(continued)

Quartz Torch

Standard Quartz Torch	30-808-8107
High Efficiency Quartz Torch	31-808-2784



Quartz Injectors (non DRC)

Tapered Quartz Injector 1.5mm	31-807-0006
Tapered Quartz Injector 1.8mm	31-807-0005
Tapered Quartz Injector 2.0mm	31-807-0004



These injectors are compatible with both D-Torch and standard torch. They are suitable for torch adaptor 31-808-2825.

Quartz Injectors (DRC Versions)

Tapered Quartz Injector with Ball Joint, 0.85mm	31-808-3125
Tapered Quartz Injector with Ball Joint, 1.5mm	31-808-0851
Tapered Quartz Injector with Ball Joint, 2.0mm	31-808-0806
Tapered Quartz Injector with Ball Joint, 2.5mm	31-808-3463



These injectors are compatible with both D-Torch and standard torch. They are suitable for torch adaptor 31-808-2824.

HF Resistant Injectors

Tapered Alumina Injector 2.0mm	31-807-0060
Sapphire Injector 2.0mm	31-808-2803



These injectors are compatible with both D-Torch and standard torch. They are suitable for torch adaptor 31-808-2825.

Torch Adaptor

Cassette Mount Adaptor for Ball Joint Injector	31-808-2824
---	-------------

This adaptor is suitable for injectors with a ball joint.



Torch Adaptor

PFA Cassette Mount Adaptor	31-808-2825
----------------------------	-------------

This adaptor is suitable for injectors without a ball joint.



Cones

Sampler Cones

Nickel Sampler	PE3011-Ni
Aluminium Sampler	PE3011-Al
Platinum Sampler	PE3013-Pt
Platinum Sampler (18mm)	PE3013A-Pt
Platinum Sampler (12mm)	PE3013C-Pt
Platinum Sampler Boron free	PE3013-Pt-BF



Skimmer Cones

Nickel Skimmer	PE3012-Ni
Aluminium Skimmer	PE3012-Al
Platinum Skimmer	PE3014-Pt
Platinum Skimmer Boron free	PE3014-Pt-BF
Aluminium Hyper Skimmer	PE3015-Al
Nickel Hyper Skimmer	PE3015-Ni
Platinum Hyper Skimmer	PE3015-Pt/Ni



O-ring for NexION Hyper Skimmer Cone (pack of 5)	PE5115
---	--------



Screw for NexION Hyper Skimmer Cone (pack of 2)	PE5116
--	--------



ConeGuard Thread Protectors

Sampler Cone Guard For NexION 300/350	70-803-1024
Skimmer Cone Guard For NexION 300/350	70-803-1026

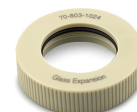

Gasket for Sampler Cone (pack of 5)	PE5111
--	--------



RF Coils

Copper 70-900-2006C



RF Coil Installation Kit 70-900-2006T



Common Accessories

Elegra Argon Humidifier

Elegra Dual Argon Humidifier 70-803-1274



Guardian In-Line Filters

Guardian DC in-line non-return gas filter 70-803-1942

Guardian in-line sample filter 70-803-1108

Eluo Adaptor for Inline Filter 70-803-1160



Trident Internal Standard Kits

Trident CT Standard Kit 60-703-1179

Standard Kit for HF solutions 60-808-1150

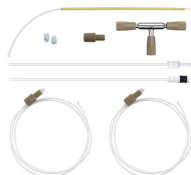

Magnifier Inspection Tool 70-803-1923



Autosampler Probes (See page 20-21 for complete list of probes)

Suitable for Cetac ASX-200/500/800 Series and PerkinElmer S20 Series

Guardian Probe 0.75mm
Probe Connecting Line (Red) 70-803-1803

*(suitable for Cetac only)



Guardian Probe 0.75mm
Probe Connecting Line (Red) 70-803-2097

*(suitable for PerkinElmer S20 Series only)



Polyimide sheathed Autosampler
Probe 0.5mm ID 60-808-1186L

PTFE Encapsulated Carbon Fibre
Probe 0.5mm ID 70-803-0784

PTFE Encapsulated Carbon Fibre
Probe 0.75mm ID 70-803-1443

PTFE Encapsulated Carbon Fibre
Probe 1.0mm ID 70-803-0793



Suitable for PE S10 or AS93+

PTFE Encapsulated Carbon
Fibre Probe 0.25mm ID 70-803-1071

PTFE Encapsulated Carbon
Fibre Probe 0.5mm ID 70-803-1440

PTFE Encapsulated Carbon
Fibre Probe 1.0mm ID 70-803-0816



Glass DC Nebulizers

SeaSpray

2mL/min uptake	A21-07-USS2
400µL/min uptake	A21-07-USS04

MicroMist

600µL/min uptake	A21-07-UM06
200µL/min uptake	A21-07-UM02
100µL/min uptake	A21-07-UM01
50µL/min uptake	A21-07-UM005



Slurry

4mL/min uptake	A21-07-US6
----------------	------------

Conikal

2mL/min uptake	A21-07-UC2
1mL/min uptake	A21-07-UC1

DC Nebulizers for HF

DuraMist

1mL/min uptake	A21-07-DM1
400µL/min uptake	A21-07-DM04



OpalMist

2mL/min uptake	A21-07-PFA2
600µL/min uptake	A21-07-PFA06
200µL/min uptake	A21-07-PFA02
100µL/min uptake	A21-07-PFA01
50µL/min uptake	A21-07-PFA005



VeeSpray

0.6-3mL/min uptake	A21-07-CV6
--------------------	------------



IsoMist XR

Programmable Temperature Cyclonic Spray Chamber

IsoMist XR Kit	KT-1147-XR
----------------	------------

Comprises:

Glass Twister Spray Chamber Assembly (LOL)	21-809-4347
PuraFlex Transfer Tube	20-809-5175
Metal Ball Joint Clip	21-809-4350
UniFit Right Angle Connector (PKT 3)	JC-13
	GAZ-04-90



Spray Chambers

Twister

50mL Cyclonic	20-809-0495HE
---------------	---------------



Tracey

50mL Cyclonic	20-808-8882HE
---------------	---------------



Cinnabar

20mL Cyclonic	20-809-0164HE
---------------	---------------



Twinnabar

20mL Cyclonic	20-809-0498HE
---------------	---------------



HydraMist Simultaneous Cold Vapor/ Pneumatic Nebulization Spray Chamber

Hydride Kit	KT-1157
Hydride Kit for Avio with HTS system	KT-2742



Spray Chambers for HF

Twister TFE

50mL Cyclonic	20-809-3452
---------------	-------------



Tracey TFE

50mL Cyclonic	20-809-2507
---------------	-------------



Torches

D-Torch for Avio 200

D-Torch 30-808-3800



Comprises:

Base and Inner Tube 31-808-3802

Quartz Outer Tube 31-808-3792

Retaining Ring 31-808-2818

D-Torch Options:

Ceramic Outer Tube 31-808-3820

Injector Adapter 31-808-3782

Viton O-Rings (Pkt 10) 70-803-1576



D-Torch for Avio 500

D-Torch 30-808-3882



Comprises:

Base and Inner Tube 31-808-3883

Quartz Outer Tube 31-808-3792

Retaining Ring 31-808-2818

D-Torch Options:

Ceramic Outer Tube 31-808-3894

Injector Adapter 31-808-3782

Viton O-Rings (Pkt 10) 70-803-1576



Tapered Injectors for D-Torch

Quartz Injector 0.8mm 31-808-3785

Quartz Injector 1.2mm 31-808-3786

Quartz Injector 1.6mm 31-808-3788

Quartz Injector 2.0mm 31-808-3789

Alumina Injector 1.25mm 31-808-3799

Alumina Injector 2.0mm 31-808-3783



Capillary Injectors for D-Torch

Sapphire Injector 1.5mm 31-808-4296

Sapphire Injector 2.0mm 31-808-3784

Fixed Torch for Avio 200/500

Quartz Torch with single slot 31-808-3776

Quartz Torch with 3 slots 31-808-4233



Purge Windows for Avio 500

Optical Kit 70-803-1634

Radial Purge Extension 70-803-2033

Axial Purge Window 31-808-2649

Optical Oring Kit 70-803-2802

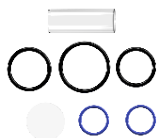

Common Accessories

Elegra Argon Humidifier

Elegra Argon Humidifier 70-803-1269



Guardian In-Line Filters

Guardian DC in-line non-return gas filter 70-803-1942

Guardian in-line sample filter 70-803-1108

Eluo Adaptor for Inline Filter 70-803-1160



Trident Internal Standard Kits

Trident CT Standard Kit 60-703-1179

Standard Kit for HF 60-808-1150

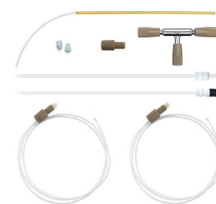

Magnifier Inspection Tool 70-803-1923



Autosampler Probes (See page 20-21 for complete list of probes)

Suitable for Cetac ASX-200/500/800 Series

Guardian Probe 0.75mm Probe Connecting Line (Red) 70-803-1803

Polyimide sheathed Autosampler Probe 0.5mm ID 60-808-1186L

PTFE Encapsulated Carbon Fibre Probe 0.5mm ID 70-803-0784

PTFE Encapsulated Carbon Fibre Probe 0.75mm ID 70-803-1443

PTFE Encapsulated Carbon Fibre Probe 1.0mm ID 70-803-0793



Suitable for PE S10 or AS93+

PTFE Encapsulated Carbon Fibre Probe 0.25mm ID 70-803-1071

PTFE Encapsulated Carbon Fibre Probe 0.5mm ID 70-803-1440

PTFE Encapsulated Carbon Fibre Probe 1.0mm ID 70-803-0816



Glass DC Nebulizers

SeaSpray

2mL/min uptake	A21-07-USS2
400µL/min uptake	A21-07-USS04

MicroMist

600µL/min uptake	A21-07-UM06
200µL/min uptake	A21-07-UM02
100µL/min uptake	A21-07-UM01
50µL/min uptake	A21-07-UM005



Conikal

2mL/min uptake	A21-07-UC2
1mL/min uptake	A21-07-UC1

Slurry

4mL/min uptake	A21-07-US6
----------------	------------

DC Nebulizers for HF

DuraMist

1mL/min uptake	A21-07-DM1
400µL/min uptake	A21-07-DM04



OpalMist

2mL/min uptake	A21-07-PFA2
600µL/min uptake	A21-07-PFA06
200µL/min uptake	A21-07-PFA02
100µL/min uptake	A21-07-PFA01
50µL/min uptake	A21-07-PFA005



VeeSpray

0.6 - 3mL/min uptake	A21-07-CV6
----------------------	------------



IsoMist XR

Programmable Temperature Cyclonic Spray Chamber

IsoMist XR Kit	KT-1012-XR
----------------	------------

Comprises:

Glass Twister Spray Chamber Assembly (LOL)	21-809-3185
IsoMist Mount	21-809-2773
Adaptor GAZ08-12 90deg	21-809-2871
Clamping Screw	21-808-0953
UniFit Right Angle Connector (PKT 3)	GAZ-04-90



Spray Chambers

Tracey

50mL Cyclonic	20-809-0434HE
---------------	---------------



Twister

50mL Cyclonic (Aqueous)	20-809-0208HE
With 7mm baffle	



Twister

50mL Cyclonic (Organics)	20-809-0446HE
With 4mm baffle	



Twister

50mL Cyclonic (Aux. Port)	20-809-0004HE
---------------------------	---------------



Cinnabar

20mL Cyclonic	20-809-9121HE
---------------	---------------



HydraMist Simultaneous Cold Vapor/ Pneumatic Nebulization Spray Chamber

HydraMist Kit	KT-1162
---------------	---------



Spray Chambers for HF

Tracey TFE

50mL Cyclonic	20-809-2510
Plugs directly into cassette mount	



Torches

D-Torch 30-808-3300 

Comprises:

Base and Inner Tube 31-808-3292

Quartz Outer Tube 31-808-3294

Retaining Ring 31-808-2818

D-Torch Options

Ceramic Outer Tube 31-808-2990 

Copper Foils (PKT 12) for Ceramic Outer Tube 31-808-3356

O-Ring Kit 70-803-0762

Quartz Torch

Without slots 31-808-3254 

With single slot 31-808-3255

With 3 slots 31-808-3256

Quartz Torch Options:

Copper Foil for Quartz Torch or D-Torch Quartz Outer Tube (pack of 12) 31-808-3289

Tapered Quartz Injectors

Quartz Injector 0.8mm 31-808-3257 

Quartz Injector 2.0mm 31-808-3258

Alumina Injector 1.2mm 31-808-3287

Alumina Injector 2.0mm 31-808-3286 

Sapphire Injectors

Sapphire Injector 2mm 31-808-3528

Purge Windows

Axial 17mm disk 31-808-0551 

Axial 32mm disk 31-808-2649

Radial (Post Nov. 2004) 31-808-2788

Common Accessories

Elegra Argon Humidifier

Elegra Argon Humidifier 70-803-1269 

Guardian In-Line Filters

Guardian DC in-line non-return gas filter 70-803-1942 

Guardian in-line sample filter 70-803-1108

Eluo Adaptor for Inline Filter 70-803-1160

Trident Internal Standard Kits

Trident CT Standard Kit 60-703-1179 

Standard Kit for HF solutions 60-808-1150 

Magnifier Inspection Tool 70-803-1923 

Autosampler Probes (See page 20-21 for complete list of probes)

Suitable for Cetac ASX-200/500/800 Series

Guardian Probe 0.75mm Probe Connecting Line (Red) 70-803-1803 

Polyimide sheathed Autosampler Probe 0.5mm ID 60-808-1186L

PTFE Encapsulated Carbon Fibre Probe 0.5mm ID 70-803-0784

PTFE Encapsulated Carbon Fibre Probe 0.75mm ID 70-803-1443

PTFE Encapsulated Carbon Fibre Probe 1.0mm ID 70-803-0793

Suitable for PE S10 or AS93+

PTFE Encapsulated Carbon Fibre Probe 0.25mm ID 70-803-1071 

PTFE Encapsulated Carbon Fibre Probe 0.5mm ID 70-803-1440

PTFE Encapsulated Carbon Fibre Probe 1.0mm ID 70-803-0816

Glass DC Nebulizers

Conikal	
1mL/min uptake	A41-1-UC1S
SeaSpray	
400µL/min uptake	A41-07-USS04S
Slurry	
4mL/min uptake	A41-1-US6
MicroMist	
600µL/min uptake	A41-07-UM06S
400µL/min uptake	A41-07-UM04
200µL/min uptake	A41-07-UM02
100µL/min uptake	A41-07-UM01
50µL/min uptake	A41-07-UM005



Quartz DC Nebulizers

SeaSpray	
1mL/min uptake	A41-1-QSS1



DC Nebulizers Compatible with HF

OpalMist	
1mL/min uptake	A41-1-PFA1S
400µL/min uptake	A41-07-PFA04
200µL/min uptake	A41-07-PFA02
100µL/min uptake	A41-07-PFA01
50µL/min uptake	A41-07-PFA005



DuraMist	
1mL/min uptake	A41-1-DM1S
400µL/min uptake	A41-07-DM04S



VeeSpray	
0.6 - 3mL/min uptake	A41-1-CV6



Spray Chambers

Glass	
50mL Cyclonic	20-809-5042
With B14 gravity drain	



Quartz	
50mL Cyclonic	20-809-5044
With B14 gravity drain	



Drain Device	21-809-4197
---------------------	-------------



Extention Pipe	
with Aux Gas Port	70-803-2134



Dilution Gas Tube	
800mm	70-803-1766



Spray Chambers Compatible with HF

PFA	
50mL Cyclonic	20-809-5043



HF Drain Device	21-809-2540
------------------------	-------------

Extention Pipe	
with Aux Gas Port	21-809-4857



Torches

Quartz Mini Torches

Torch with 1.5mm Injector	30-808-4258
Torch with 1.8mm Injector	30-808-4265

Demountable Torch for HF

Mini Torch Kit	30-808-4282
----------------	-------------

Comprises:

Quartz Torch Body	31-808-4283
Alumina Injector 1.5mm	31-808-0774
PEEK Injector Adaptor	31-808-4478



Cones

Sampler Cones

Nickel Sampler	SZ7011-NiP
----------------	------------



Platinum Sampler	SZ7013-PtP
------------------	------------



Gasket for Sampler Cone (PKT 3)	SZ5001
---------------------------------	--------

Screw Kit for Sampler Cone (PKT 4)	SZ5004
------------------------------------	--------



Skimmer Cones

Copper Skimmer	SZ7002-Cu
----------------	-----------



Nickel Skimmer Small	SZ7022-Ni
----------------------	-----------

Spacer for Skimmer Small	SZ5005
--------------------------	--------

Platinum Skimmer	SZ7004-Pt/Cu
------------------	--------------

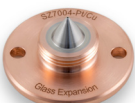

Screw Kit for Skimmer Cone (PKT 2)	SZ5002
------------------------------------	--------

Cone Extraction Tool	70-803-1573
----------------------	-------------



Common Accessories

Elegra Argon Humidifier

Elegra Argon Humidifier	70-803-1312
Elegra Dual-Channel Argon Humidifier	70-803-1473
Dilution Gas Tube	70-803-2764



Guardian In-Line Filters

Guardian DC in-line non-return gas filter	70-803-1942
Guardian in-line sample filter	70-803-1108
Eluo Adaptor for Inline Filter	70-803-1160



Trident Internal Standard Kits

Trident CT Standard Kit	60-703-1179
Standard Kit for HF	60-808-1150

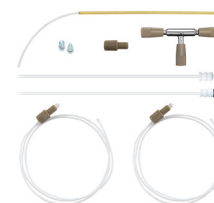

Magnifier Inspection Tool 70-803-1923



Autosampler Probes (See page 20-21 for complete list of probes)

For Cetac ASX-200/500/800 Series

Guardian Probe 0.75mm	
Probe Connecting Line (Red)	70-803-1803
Polyimide sheathed Autosampler Probe	
0.5mm ID	60-808-1186L
PTFE Encapsulated Carbon Fibre Probe	
0.5mm ID	70-803-0784
PTFE Encapsulated Carbon Fibre Probe	
0.75mm ID	70-803-1443
PTFE Encapsulated Carbon Fibre Probe	
1.0mm ID	70-803-0793



Glass DC Nebulizers

Conikal	
1mL/min uptake	A41-1-UC1S
SeaSpray	
400µL/min uptake	A41-07-USS04S
Slurry	
4mL/min uptake	A41-1-US6
MicroMist	
600µL/min uptake	A41-07-UM06S
200µL/min uptake	A41-07-UM02
100µL/min uptake	A41-07-UM01
50µL/min uptake	A41-07-UM005



Quartz DC Nebulizers

SeaSpray	
1mL/min uptake	A41-1-QSS1



DC Nebulizers Compatible with HF

OpalMist	
1mL/min uptake	A41-1-PFA1S
400µL/min uptake	A41-07-PFA04
200µL/min uptake	A41-07-PFA02
100µL/min uptake	A41-07-PFA01
50µL/min uptake	A41-07-PFA005



DuraMist	
1mL/min uptake	A41-1-DM1S
400µL/min uptake	A41-07-DM04S



VeeSpray	
0.6 - 3mL/min uptake	A41-1-CV6



Spray Chambers

Glass	
50mL Cyclonic	21-809-3994
With B14 gravity drain	



Quartz	
50mL Cyclonic	21-809-3992
With B14 gravity drain	



Drain Device	21-808-8214
---------------------	-------------



Extention Pipe	
Quartz Transfer Tube	31-808-3920



Spray Chambers Compatible with HF

PFA	
50mL Cyclonic	21-809-3991



HF Drain Device	21-809-2540
------------------------	-------------



Extention Pipe	
PFA Extention w/ right angle	21-809-4081



Torches

Quartz Torches

Quartz Mini Torch 30-807-0567
(Suitable for ICP-MS 2030)

Quartz Sleeve for Mini Torch 31-808-4214
(Suitable for ICP-MS 2030)



Demountable Torch for HF

Mini Torch Kit 30-808-4401

Comprises:

Quartz Torch Body 31-808-4283

Alumina Injector 1.2mm 31-808-4353

Injector Holder 31-808-4129



RF Coils

Copper 70-900-6000C



Silver 70-900-6000S



Gold 70-900-6000G



RF Coil Installation Kit

RF Coil Installation Kit 70-900-6000T



Cones

Sampler Cones

Copper Sampler SZ7001-Cu



Nickel Sampler SZ7001-Ni



Nickel Sampler with Copper Base SZ7001-Ni/Cu

Platinum Sampler (10mm Insert) SZ7003-Pt/Cu



Gasket for Sampler Cone (PKT 3) SZ5001

Screw Kit for Sampler Cone (PKT 4) SZ5004



O-Ring Kit 70-803-1908



Skimmer Cones

Copper Skimmer SZ7002-Cu



Nickel Skimmer SZ7002-Ni



Nickel Skimmer with Copper Base SZ7002-Ni/Cu



Platinum Skimmer SZ7004-Pt/Cu

Screw Kit for Skimmer Cone (PKT 2) SZ5002



Cone Extraction Tool 70-803-1573

Common Accessories

Elegra Argon Humidifier

Elegra Argon Humidifier 70-803-1312



Guardian In-Line Filters

Guardian DC in-line non-return gas filter 70-803-1942

Guardian in-line sample filter 70-803-1108

Eluo Adaptor for Inline Filter 70-803-1160



Trident Internal Standard Kits

Trident CT Standard Kit 60-703-1179

Standard Kit for HF 60-808-1150

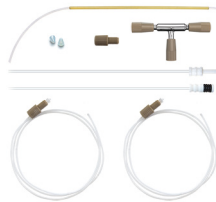

Magnifier Inspection Tool 70-803-1923



Autosampler Probes (See page 20-21 for complete list of probes)

For Cetac ASX-200/500/800 Series

Guardian Probe 0.75mm
Probe Connecting Line (Red) 70-803-1803

Polyimide sheathed Autosampler Probe
0.5mm ID 60-808-1186L

PTFE Encapsulated Carbon Fibre Probe
0.5mm ID 70-803-0784

PTFE Encapsulated Carbon Fibre Probe
0.75mm ID 70-803-1443

PTFE Encapsulated Carbon Fibre Probe
1.0mm ID 70-803-0793



For Shimadzu AS10

PTFE Sheathed Carbon Fibre Probe
0.75mm ID with UniFit 70-803-1477



Glass DC Nebulizers

Conikal	
1mL/min uptake	A41-1-UC1S
SeaSpray	
2mL/min uptake	A41-1-USS2S
Slurry	
4mL/min uptake	A41-1-US6
MicroMist	
600µL/min uptake	A41-07-UM06S
200µL/min uptake	A41-07-UM02
100µL/min uptake	A41-07-UM01
50µL/min uptake	A41-07-UM005



IsoMist XR

Programmable Temperature Cyclonic Spray Chamber

IsoMist XR Kit KT-2749-XR

Requires peristaltic pump

Comprises:

Glass Twister Spray Chamber	21-809-3186
Assembly (ROL)	20-809-5176
Adaptor	21-809-3998
Adjustable Stand	21-809-4911
Metal Ball Joint Clip	JC-13
UniFit Drain (PKT 3)	UFT-16-75



DC Nebulizers for HF

OpalMist	
1mL/min uptake	A41-1-PFA1S
600µL/min uptake	A41-07-PFA06S
200µL/min uptake	A41-07-PFA02
100µL/min uptake	A41-07-PFA01
50µL/min uptake	A41-07-PFA005



DuraMist	
1mL/min uptake	A41-1-DM1S
400µL/min uptake	A41-07-DM04S



VeeSpray	
0.6 - 3mL/min uptake	A41-1-CV6



Spray Chambers

Tracey	
50mL Cyclonic	20-808-8881HE
With B14 gravity drain	



Twister	
50mL Cyclonic	20-809-9119HE
With B14 gravity drain	



Twister	
50mL Cyclonic	20-809-0222HE



IsoMist XR

Programmable Temperature Cyclonic Spray Chamber

IsoMist XR Kit KT-1067-XR

Comprises:

Glass Twister Spray Chamber	
With B14 drain	21-809-3270
Assembly B14 (LOL)	20-809-5187
Adaptor	21-809-3998
Adjustable Stand	70-803-2798
Metal Ball Joint Clip	JC-13
Drain Device	21-808-8214



Cinnabar	
20mL Cyclonic	20-809-0164HE



HydraMist Simultaneous Cold Vapor/ Pneumatic Nebulization Spray Chamber

Hydride Kit KT-1157



Spray Chambers

(continued)

Drain Device 21-808-8214



Transfer Tube, Spray Chamber to ICPE-9000/9800 Torch

Glass Transfer Tube 86mm 21-809-2846



Spray Chambers for HF

Tracey TFE

50mL Cyclonic 20-809-2508

With B14 gravity drain
Suitable for use with HF



HF Drain Device 21-809-2540



Mounting bracket for HF Spray Chamber 21-809-2839



Transfer Tube, Spray Chamber to ICPE-9000/9800 Torch

PFA Transfer Tube 82.5mm 31-808-3071



Torches

Semi Demountable Torch (HF)

30-808-4335

Suitable for ICPS-7500/8100 and ICPE-9000/9800

Comprises:

Torch Body 31-808-4341

Injector Adaptor 31-808-4129

Tapered Alumina Injector 1.5mm 31-808-3202

Torch Options:

Tapered Quartz Injector 1.0mm 31-808-3423

Tapered Quartz Injector 1.8mm 31-808-4005

Tapered Quartz Injector 2.0mm 31-808-4006

Tapered Quartz Injector 2.5mm 31-808-3302

Tapered Alumina Injector 2.4mm 31-808-3205

Sapphire Injector 2.0mm 31-808-3378



Viton O-rings for FDT/SDT ball joints (PKT 10) 70-V-011

GazFit Connectors (PKT 4) for 4mm OD side arms GAZ-04



Quartz Torches

Quartz Torch Standard 1.5mm Injector (Suitable for 7500/8100) 30-808-1179

Quartz Torch for Organics, 1.0mm Injector (Suitable for 7500/8100/9000/9800) 30-807-0519

Quartz Torch for High TDS, 1.8mm Injector (Suitable for 7500/8100/9000/9800) 30-807-0518

Quartz Torch for High TDS, 2.0mm Injector (Suitable for 7500/8100/9000/9800) 30-807-0564

Quartz Mini Torch 1.5mm Injector (Suitable for ICPE-9000/9800) 30-807-0534

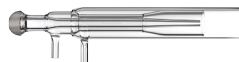

RF Coils

Copper	70-900-6100C
Silver	70-900-6100S
Gold	70-900-6100G



RF Coil Installation Kit 70-900-6100T



Common Accessories

Elegra Argon Humidifier

Elegra Argon Humidifier 70-803-1312



Guardian In-Line Filters

Guardian DC in-line non-return gas filter	70-803-1942
Guardian in-line sample filter	70-803-1108
Eluo Adaptor for Inline Filter	70-803-1160



Trident Internal Standard Kits

Trident CT Standard Kit	60-703-1179
Standard Kit for HF	60-808-1150

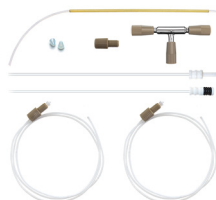

Magnifier Inspection Tool 70-803-1923



Autosampler Probes (See page 20-21 for complete list of probes)

For Cetac ASX-200/500/800 Series

Guardian Probe 0.75mm	
Probe Connecting Line (Red)	70-803-1803
Polyimide sheathed Autosampler Probe	
0.5mm ID	60-808-1186L
PTFE Encapsulated Carbon Fibre Probe	
0.5mm ID	70-803-0784
PTFE Encapsulated Carbon Fibre Probe	
0.75mm ID	70-803-1443
PTFE Encapsulated Carbon Fibre Probe	
1.0mm ID	70-803-0793



For Shimadzu AS10

PTFE Sheathed Carbon Fibre Probe	
0.75mm ID with UniFit	70-803-1477



Glass DC Nebulizers

SeaSpray

2mL/min uptake A21-1-USS2

MicroMist

400µL/min uptake A21-1-UM04

Slurry

4mL/min uptake A21-1-US6

Conikal

2mL/min uptake A21-1-UC2



Spray Chambers

Tracey

50mL Cyclonic 20-809-2665HE

**Twister**

50mL Cyclonic 20-809-2951HE

**Scott Spray Chamber**

20-809-4053

DC Nebulizers for HF

DuraMist

1mL/min uptake A21-1-DM1

400µL/min uptake A21-1-DM04

**VeeSpray**

0.6-3mL/min uptake A21-1-CV6

**HydraMist Simultaneous Cold Vapor/
Pneumatic Nebulization Spray Chamber**

Hydride Kit KT-1160

**Quartz Adaptor**

21-809-3772

**Quartz Adaptor with
Aux Port**

21-809-3771



IsoMist XR

**Programmable Temperature Cyclonic
Spray Chamber**

IsoMist XR Kit KT-1141-XR

Comprises:

Glass Twister Spray Chamber 21-809-3185

Assembly (LOL) 20-809-5175

Adaptor 12/8 for SpectroBlue 31-808-3489

Glass Ball Cup Adaptor S19 21-809-4101

Tygon Tubing 1/4 inch x 1m 1921-1M

Metal Ball Joint Clip JC-19

GazFit Connectors for 8mm
OD arm (PKT 2) GAZ-08UniFit Right Angle Connector
(PKT 3) GAZ-04-90

Spray Chambers for HF

Tracey TFE

50mL Cyclonic 20-809-3717

Suitable for use with HF.
Requires Transfer Tube 21-809-3726.**PuraFlex Transfer Tube** 21-809-3726

Torches

D-Torch Blue EOP 30-808-3600

D-Torch Blue TI 30-808-3629

Comprises:

Base and Inner Tube 31-808-3605

Quartz Outer Tube 31-808-3630

Injector Ferrule 31-808-2962

Retaining Ring 31-808-3595

Adaptor for D-Torch B19 31-808-3651

Adaptor S19-B19-90deg 21-809-4045

Metal Ball Joint Clip JC-19



D-Torch Options:

Sheath Gas Adaptor 21-809-4082

Aux Gas Line 70-803-1424

Tapered Injectors for Blue EOP/TI

D-Torch

Quartz Injector 1.0mm 31-808-0009

Quartz Injector 1.2mm 31-808-3643

Quartz Injector 1.5mm 31-808-0007

Quartz Injector 1.8mm 31-808-8146

Quartz Injector 2.0mm 31-808-0008

Quartz Injector 2.4mm 31-808-3541

Quartz Injector 2.5mm 31-808-3645

Alumina Injector 1.0mm 31-808-0835

Alumina Injector 1.5mm 31-808-0013

Alumina Injector 1.8mm 31-808-0015

Alumina Injector 2.0mm 31-808-0027



Capillary Injectors for Blue EOP/TI

D-Torch

Alumina Injector 1.8mm 31-808-0087



Torches

(continued)

**D-Torch
ARCOS II EOP** 30-808-3657

Comprises:

Base and Inner Tube 31-808-3660

Quartz Outer Tube 31-808-3658

Injector Ferrule 31-808-2962

Retaining Ring 31-808-3595

Adaptor for D-Torch B19 31-808-3651

Adaptor S19-B19-90deg 21-809-4045

Metal Ball Joint Clip JC-19

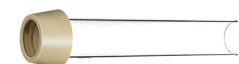

D-Torch Options:

Sheath Gas Adaptor 21-809-4082

Adaptor S19-B13-90deg 21-809-4048

Tapered Injectors for ARCOS II EOP

D-Torch

Quartz Injector 2.5mm 31-808-3676

Alumina Injector 2.0mm 31-808-3699

Alumina Injector 2.4mm 31-808-3700



Capillary Injectors for ARCOS II EOP

D-Torch

Sapphire Injector 2.0mm 31-808-3718

Sapphire Injector 2.4mm 31-808-3850



Quartz Torch

SpectroBlue EOP 31-808-3394

SpectroBlue TI 31-808-3468



Injectors for Quartz Torch

Quartz Injector 1.2mm 31-808-3410

Quartz Injector 1.8mm 31-808-3391

Quartz Injector 2.0mm 31-808-3411

Quartz Injector 3.0mm 31-808-3412

Alumina Injector 1.8mm 31-808-3409

Alumina Injector 2.5mm 31-808-3390



Common Accessories

Elegra Argon Humidifier

Elegra Argon Humidifier	70-803-1269
Elegra Stand	70-803-1581



Guardian In-Line Filters

Guardian DC in-line non-return gas filter	70-803-1942
Guardian in-line sample filter	70-803-1108
Eluo Adaptor for Inline Filter	70-803-1160



Trident Internal Standard Kits

Trident CT Standard Kit	60-703-1179
Standard Kit for HF	60-808-1150

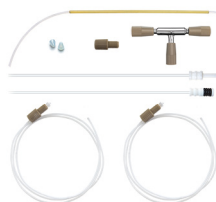

Magnifier Inspection Tool 70-803-1923



Autosampler Probes (See page 20-21 for complete list of probes)

For Cetac ASX-200/500/800 Series



Guardian Probe 0.75mm	
Probe Connecting Line (Red)	70-803-1803
Polyimide sheathed Autosampler Probe	
0.5mm ID	60-808-1186L
PTFE Encapsulated Carbon Fibre Probe	
0.5mm ID	70-803-0784
PTFE Encapsulated Carbon Fibre Probe	
0.75mm ID	70-803-1443
PTFE Encapsulated Carbon Fibre Probe	
1.0mm ID	70-803-0793





Glass DC Nebulizers

SeaSpray		
2mL/min uptake	A21-1-USS2	
MicroMist		
400µL/min uptake	A21-1-UM04	
Slurry		
4mL/min uptake	A21-1-US6	
Conikal		
2mL/min uptake	A21-1-UC2	

DC Nebulizers for HF

DuraMist		
1mL/min uptake	A21-1-DM1	
400µL/min uptake	A21-1-DM04	
VeeSpray		
0.6-3mL/min uptake	A21-1-CV6	

IsoMist XR

Programmable Temperature Cyclonic Spray Chamber		
IsoMist XR Kit	KT-1141-XR	
Comprises:		
Glass Twister Spray Chamber Assembly (LOL)	21-809-3185 20-809-5175	
Adaptor 12/8 for SpectroBlue	31-808-3489	
Glass Ball Cup Adaptor S19	21-809-4101	
Tygon Tubing 1/4 inch x 1m	1921-1M	
Metal Ball Joint Clip	JC-19	
GazFit Connectors for 8mm OD arm (PKT 2)	GAZ-08	
UniFit Right Angle Connector (PKT 3)	GAZ-04-90	

Spray Chambers

Tracey		
50mL Cyclonic	20-809-2665HE	
Twister		
50mL Cyclonic	20-809-2951HE	

HydraMist Simultaneous Cold Vapor/ Pneumatic Nebulization Spray Chamber		
Hydride Kit	KT-1160	

Straight Quartz Adaptor	21-809-3773	
--------------------------------	-------------	--

Straight Quartz Adaptor with Aux Port	21-809-3804	
--	-------------	---

Sheath Gas Adaptor	21-809-4083	
---------------------------	-------------	---

Spray Chambers for HF

Tracey TFE		
50mL Cyclonic	20-809-3717	
Suitable for use with HF. Requires Transfer Tube	21-809-3727	

Straight HF Resistant Adaptor	21-809-3727	
--------------------------------------	-------------	---

Torches

Quartz Torch

SpectroBlue SOP 31-808-3405



Injectors for Quartz Torch

Quartz Injector 1.0mm 31-808-4148

Quartz Injector 1.2mm 31-808-3410

Quartz Injector 1.5mm 31-808-4234

Quartz Injector 1.8mm 31-808-3391

Quartz Injector 2.0mm 31-808-3411

Quartz Injector 2.5mm 31-808-4235

Quartz Injector 3.0mm 31-808-3412

Alumina Injector 1.8mm 31-808-3409

Alumina Injector 2.5mm 31-808-3390



Fixed Quartz Torch

Quartz Torch 1.8mm injector S19, SOP 30-808-4264



Fixed Quartz Torch

Quartz Torch 2.0mm injector S19, SOP 30-808-4403



Common Accessories

Elegra Argon Humidifier

Elegra Argon Humidifier 70-803-1269



Elegra Stand 70-803-1581



Guardian In-Line Filters

Guardian DC in-line non-return gas filter 70-803-1942

Guardian in-line sample filter 70-803-1108

Eluo Adaptor for Inline Filter 70-803-1160



Common Accessories

(continued)

Trident Internal Standard Kits

Trident CT Standard Kit 60-703-1179

Standard Kit for HF 60-808-1150

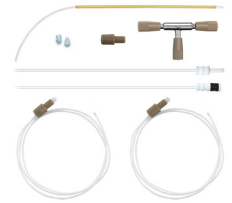

Magnifier Inspection Tool 70-803-1923



Autosampler Probes (See page 20-21 for complete list of probes)

For Cetac ASX-200/500/800 Series

Guardian Probe 0.75mm

Probe Connecting Line (Red) 70-803-1803

Polyimide sheathed Autosampler Probe 0.5mm ID 60-808-1186L

PTFE Encapsulated Carbon Fibre Probe 0.5mm ID 70-803-0784

PTFE Encapsulated Carbon Fibre Probe 0.75mm ID 70-803-1443

PTFE Encapsulated Carbon Fibre Probe 1.0mm ID 70-803-0793



Glass DC Nebulizers

SeaSpray

400µL/min uptake A13-1-USS04



MicroMist

400µL/min uptake A13-1-UM04

Quartz DC Nebulizers

SeaSpray

1mL/min uptake A13-1-QSS1



DC Nebulizers for HF

OpalMist

400µL/min uptake A13-1-PFA04

200µL/min uptake A13-1-PFA02

100µL/min uptake A13-1-PFA01

50µL/min uptake A13-1-PFA005



DC Nebulizers for HE-SIS

MicroMist HE

200µL/min uptake C13-1-UFT02

200µL/min uptake E13-1-UFT02



Spray Chambers

High Efficiency Sample Introduction System

HE-SIS for Thermo ICP-MS KT-1172



Torches

Quartz Torch

Base for Q Torch 31-808-3494



Quartz Tube Set 31-808-3357



Ceramic Torch

Ceramic Outer Tube Set 31-808-4048



Torch Options:

Quartz Injector 1.0mm 31-808-3440

Quartz Injector 2.0mm 31-808-3898

Quartz Injector 2.5mm 31-808-3428

Sapphire Injector 2.0mm 31-808-4014

Tapered Alumina Injector 2.0mm 31-808-4012

O-ring Kit for Q Torch base (31-808-3494) 70-803-1535

O-ring Kit for Thermo Q Torch base 70-803-1611



Cones

Sampler Cones

Nickel Sampler with Copper Core TG1021-Ni/Cu

Platinum Sampler with Copper Core TG1026A-Pt/Cu



Skimmer Cones

Nickel Skimmer TG1054-Ni

Platinum Skimmer TG1058-Pt

Cone Extraction Tool 70-803-2050

Graphite Sampler Cone Gasket TG5001



Common Accessories

Elegra Argon Humidifier

Elegra Argon Humidifier 70-803-1268

Elegra Dual Channel Argon Humidifier 70-803-2827



Guardian In-Line Filters

Guardian DC in-line non-return gas filter 70-803-1942

Guardian in-line sample filter 70-803-1108

Eluo Adaptor for Inline Filter 70-803-1160



Trident Internal Standard Kits

Trident CT Standard Kit 60-703-1179

Standard Kit for HF 60-808-1150

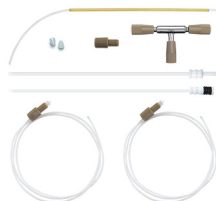

Magnifier Inspection Tool 70-803-1923



Autosampler Probes (See page 20-21 for complete list of probes)

For Cetac ASX-200/500/800 Series

Guardian Probe 0.75mm Probe Connecting Line (Red) 70-803-1803

Guardian Probe iSC-65 0.75mm Probe Connecting Line (Red) 70-803-2106

PTFE Encapsulated Carbon Fibre Probe 0.5mm ID 70-803-0784

PTFE Encapsulated Carbon Fibre Probe 0.75mm ID 70-803-1443

PTFE Encapsulated Carbon Fibre Probe 1.0mm ID 70-803-0793



Glass DC Nebulizers

SeaSpray

400µL/min uptake A31-1-USS04

MicroMist

400µL/min uptake A31-1-UM04

200µL/min uptake A31-1-UM02

100µL/min uptake A31-1-UM01

50µL/min uptake A31-1-UM005



Quartz DC Nebulizers

SeaSpray

1mL/min uptake A31-1-QSS1



DC Nebulizers for HF

OpalMist

400µL/min uptake A31-1-PFA04

200µL/min uptake A31-1-PFA02

100µL/min uptake A31-1-PFA01

50µL/min uptake A31-1-PFA005



DC Nebulizers for HE-SIS

MicroMist HE

200µL/min uptake C13-1-UFT02

200µL/min uptake E13-1-UFT02



Spray Chambers

High Efficiency Sample Introduction System

HE-SIS for Thermo Q/RQ/TQ ICP-MS KT-1172



Torches

Quartz Torch

Base for Q Torch 31-808-3494



Quartz Tube Set 31-808-3357



Ceramic Torch

Ceramic Outer Tube Set 31-808-4048



Torch Options:

Quartz Injector 1.0mm 31-808-3440

Quartz Injector 2.0mm 31-808-3898

Quartz Injector 2.5mm 31-808-3428

Sapphire Injector 2.0mm 31-808-4014

Tapered Alumina Injector 2.0mm 31-808-4012

O-ring Kit for Q Torch base (31-808-3494) 70-803-1535



Cones

Sampler Cones

Nickel Sampler with Copper Core	TG1021-Ni/Cu
Aluminium Sampler	TG1021-Al
Platinum Sampler with Copper Core	TG1026A-Pt/Cu



Skimmer Cones

Nickel Skimmer Hot and Cold Plasma	TG1035-Ni
Platinum Skimmer Hot and Cold Plasma	TG1039-Pt



Nickel Skimmer (Robust Plasma)	TG1045-Ni
--------------------------------	-----------

Eliminates need for insert.

Nickel Skimmer (High Matrix)	TG1044-Ni
------------------------------	-----------

Eliminates need for insert.

Platinum Skimmer (High Matrix)	TG1048-Pt
--------------------------------	-----------

Eliminates need for insert.

Cone Extraction Tool	70-803-2050
----------------------	-------------

Skimmer Cone Guard	70-803-1028
--------------------	-------------

Graphite Sampler Cone Gasket	TG5001
------------------------------	--------



Cone Extraction Tool	70-803-2050
----------------------	-------------



Common Accessories

Elegra Argon Humidifier

Elegra Argon Humidifier	70-803-1268
-------------------------	-------------



Guardian In-Line Filters

Guardian DC in-line non-return gas filter	70-803-1942
Guardian in-line sample filter	70-803-1108
Eluo Adaptor for Inline Filter	70-803-1160



Trident Internal Standard Kits

Trident CT Standard Kit	60-703-1179
Standard Kit for HF	60-808-1150

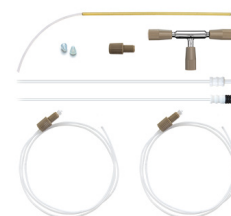

Magnifier Inspection Tool 70-803-1923



Autosampler Probes (See page 20-21 for complete list of probes)

For Cetac ASX-200/500/800 Series

Guardian Probe 0.75mm	
Probe Connecting Line (Red)	70-803-1803
Polyimide sheathed Autosampler Probe 0.5mm ID	60-808-1186L
PTFE Encapsulated Carbon Fibre Probe 0.5mm ID	70-803-0784
PTFE Encapsulated Carbon Fibre Probe 0.75mm ID	70-803-1443
PTFE Encapsulated Carbon Fibre Probe 1.0mm ID	70-803-0793



Glass DC Nebulizers

SeaSpray

400µL/min uptake A31-1-USS04

MicroMist

400µL/min uptake A31-1-UM04

200µL/min uptake A31-1-UM02

100µL/min uptake A31-1-UM01

50µL/min uptake A31-1-UM005



Quartz DC Nebulizers

SeaSpray

1mL/min uptake A31-1-QSS1



DC Nebulizers for HF

OpalMist

400µL/min uptake A31-1-PFA04

200µL/min uptake A31-1-PFA02

100µL/min uptake A31-1-PFA01

50µL/min uptake A31-1-PFA005



DC Nebulizers for HE-SIS

MicroMist HE

200µL/min uptake C13-1-UFT02

200µL/min uptake E13-1-UFT02



Spray Chambers

High Efficiency Sample Introduction System

HE-SIS for Thermo Neoma MC-ICP-MS KT-1172



Torches

Quartz Torch

Base for Q Torch 31-808-3494

Quartz Tube Set 31-808-3357

Ceramic Torch

Ceramic Tube Set 31-808-4048

Torch Options:

Quartz Injector 1.0mm 31-808-3440

Quartz Injector 2.0mm 31-808-3898

Quartz Injector 2.5mm 31-808-3428

Sapphire Injector 2.0mm 31-808-4014

Tapered Alumina Injector 2.0mm 31-808-4012

O-ring Kit for Q Torch base (31-808-3494) 70-803-1535



Cones

Sampler Cones

Nickel Jet Sampler TF1005-Ni

Nickel Sampler with Copper Core TF1001-Ni/Cu

Platinum Sampler with Copper Core TF1006-Pt/Cu



Skimmer Cones

Nickel Skimmer TF1002A-Ni

Nickel X Skimmer with Copper Core TF1002X-Ni

Platinum Skimmer (H, boron-free) TF1008-Pt



Graphite Sampler Cone Gasket

TG5001



Common Accessories

Elegra Argon Humidifier

Elegra Argon Humidifier 70-803-1268



Guardian In-Line Filters

Guardian DC in-line non-return gas filter 70-803-1942

Guardian in-line sample filter 70-803-1108

Eluo Adaptor for Inline Filter 70-803-1160



Trident Internal Standard Kits

Trident CT Standard Kit 60-703-1179

Standard Kit for HF 60-808-1150

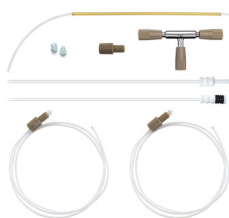

Magnifier Inspection Tool 70-803-1923



Autosampler Probes (See page 20-21 for complete list of probes)

For Cetac ASX-200/500/800 Series

Guardian Probe 0.75mm Probe Connecting Line (Red) 70-803-1803

Guardian Probe ASX-112FR 70-803-2029

Polyimide sheathed Autosampler Probe 0.5mm ID 60-808-1186L

PTFE Encapsulated Carbon Fibre Probe 0.5mm ID 70-803-0784

PTFE Encapsulated Carbon Fibre Probe 0.75mm ID 70-803-1443

PTFE Encapsulated Carbon Fibre Probe 1.0mm ID 70-803-0793

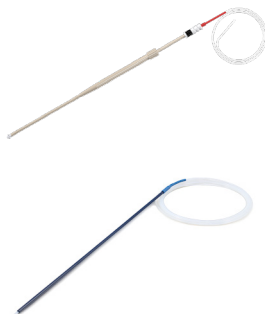

Glass DC Nebulizers

SeaSpray

2mL/min uptake	A31-07-USS2
400µL/min uptake	A31-07-USS04

MicroMist

600µL/min uptake	A31-07-UM06
200µL/min uptake	A31-07-UM02
100µL/min uptake	A31-07-UM01
50µL/min uptake	A31-07-UM005



Conikal

2mL/min uptake	A31-07-UC2
1mL/min uptake	A31-07-UC1

Slurry

4mL/min uptake	A31-07-US6
----------------	------------

DC Nebulizers for HF

DuraMist

1mL/min uptake	A31-07-DM1
400µL/min uptake	A31-07-DM04



OpalMist

2mL/min uptake	A31-07-PFA2
600µL/min uptake	A31-07-PFA06
200µL/min uptake	A31-07-PFA02
100µL/min uptake	A31-07-PFA01
50µL/min uptake	A31-07-PFA005



VeeSpray

0.6 - 3mL/min uptake	A31-07-CV6
----------------------	------------



IsoMist XR

Programmable Temperature Cyclonic Spray Chamber

IsoMist XR Kit	KT-1166-XR
----------------	------------

Comprises:

Glass Twister Spray Chamber Assembly (LOL)	21-809-3185
PuraFlex Transfer Tube	20-809-5175
UniFit Right Angle Connector (PKT 3)	21-809-4426
	GAZ-04-90



Spray Chambers

Tracey

50mL Cyclonic	20-809-2665HE
---------------	---------------



Twister

50mL Cyclonic	20-809-2951HE
---------------	---------------



Straight Ball Joint Adaptor

21-809-2723



Sheath Gas Adaptor

31-808-3891



HydraMist Simultaneous Cold Vapor/ Pneumatic Nebulization Spray Chamber

Hydride Kit	KT-1160
-------------	---------



Spray Chambers for HF

Tracey TFE

50mL Cyclonic	20-809-9198
---------------	-------------



Torches

D-Torch 30-808-4150



Comprises:

Base and Inner Tube 31-808-4255

Quartz Outer Tube with slot 31-808-4152



D-Torch Options:

Ceramic Outer Tube with slot 31-808-3996



Retaining Ring 31-808-2707

Injector Adaptor 31-808-2895

Injector Ferrule 31-808-2897



D-Torch

D-Torch Options:

PTFE Coated
Viton O-rings (PKT 10) VT-007



O-ring kit for Thermo
6000/7000/PRO D-Torch 70-803-1921

O-ring and Seal kit for Thermo
Torch & Windows 70-803-1550



Quartz Torch

EMT Design 31-808-4158



**Tapered Injectors for
D-Torch & EMT Torch**

Quartz Injector 0.75mm 31-808-3511

Quartz Injector 1.0mm 31-808-2833

Quartz Injector 1.5mm 31-808-2834



**Capillary Injectors for
D-Torch & EMT Torch**

Quartz Injector 1.0mm 31-808-3510

Quartz Injector 2.0mm 31-808-2836

Quartz Injector 2.5mm 31-808-3246

Quartz Injector 3.0mm 31-808-3247

Alumina Injector 1.0mm 31-808-3279

Alumina Injector 2.0mm 31-808-2835

Sapphire Injector 2.0mm 31-808-2977



RF Coils

RF Coil for PRO

Silver 70-900-4006S



Gold 70-900-4006G



RF Coil Installation Kit 70-900-4006T



Common Accessories

Elegra Argon Humidifier

Elegra Argon Humidifier 70-803-1268



Guardian In-Line Filters

Guardian DC in-line non-return
gas filter 70-803-1942

Guardian in-line sample filter 70-803-1108

Eluo Adaptor for Inline Filter 70-803-1160



Trident Internal Standard Kits

Trident CT Standard Kit 60-703-1179

Standard Kit for HF 60-808-1150

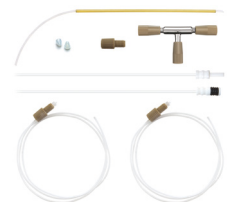

Magnifier Inspection Tool 70-803-1923



Autosampler Probes (See page 20-21 for complete list of probes)

For Cetac ASX-200/500/800 Series

Guardian Probe 0.75mm
Probe Connecting Line (Red) 70-803-1803

Polyimide sheathed Autosampler
Probe 0.5mm ID 60-808-1186L

PTFE Encapsulated Carbon
Fibre Probe 0.5mm ID 70-803-0784

PTFE Encapsulated Carbon
Fibre Probe 0.75mm ID 70-803-1443

PTFE Encapsulated Carbon
Fibre Probe 1.0mm ID 70-803-0793



Glass DC Nebulizers

SeaSpray

2mL/min uptake	A31-07-USS2
400µL/min uptake	A31-07-USS04

MicroMist

600µL/min uptake	A31-07-UM06
200µL/min uptake	A31-07-UM02
100µL/min uptake	A31-07-UM01
50µL/min uptake	A31-07-UM005



Conikal

2mL/min uptake	A31-07-UC2
1mL/min uptake	A31-07-UC1

Slurry

4mL/min uptake	A31-07-US6
----------------	------------

DC Nebulizers for HF

DuraMist

1mL/min uptake	A31-07-DM1
400µL/min uptake	A31-07-DM04



OpalMist

2mL/min uptake	A31-07-PFA2
600µL/min uptake	A31-07-PFA06
200µL/min uptake	A31-07-PFA02
100µL/min uptake	A31-07-PFA01
50µL/min uptake	A31-07-PFA005



VeeSpray

0.6 - 3mL/min uptake	A31-07-CV6
----------------------	------------



IsoMist XR

Programmable Temperature Cyclonic Spray Chamber

IsoMist XR Kit	KT-1166-XR
----------------	------------

Comprises:

Glass Twister Spray Chamber Assembly (LOL)	21-809-3185
PuraFlex Transfer Tube	21-809-4426
UniFit Right Angle Connector (PKT 3)	GAZ-04-90



Spray Chambers

Tracey

50mL Cyclonic	20-809-2665HE
---------------	---------------



Twister

50mL Cyclonic	20-809-2951HE
---------------	---------------



Straight Ball Joint Adaptor

21-809-2723



Sheath Gas Adaptor

31-808-3891



HydraMist Simultaneous Cold Vapor/Pneumatic Nebulization Spray Chamber

Hydride Kit	KT-1160
-------------	---------



Spray Chambers for HF

Tracey TFE

50mL Cyclonic	20-809-9198
---------------	-------------



Torches

D-Torch

30-808-2877

Comprises:

Base and Inner Tube 31-808-2932
 Quartz Outer Tube 31-808-2878



D-Torch Options:

Ceramic Outer Tube 31-808-3836
 PTFE Coated
 Viton O-rings (PKT 10) VT-007
 Viton O-rings (PKT 10) V-026
 O-ring kit for Thermo 6000/7000/PRO D-Torch 70-803-1921
 O-ring and Seal kit for Thermo Torch & Windows 70-803-1550
 Retaining Ring 31-808-2707
 Injector Adaptor 31-808-2895
 Injector Ferrule 31-808-2897



Quartz Torch

EMT Design 31-808-2810



Tapered Injectors for D-Torch & EMT Torch

Quartz Injector 0.75mm 31-808-3511
 Quartz Injector 1.0mm 31-808-2833
 Quartz Injector 1.5mm 31-808-2834



Capillary Injectors for D-Torch & EMT Torch

Quartz Injector 1.0mm 31-808-3510
 Quartz Injector 2.0mm 31-808-2836
 Quartz Injector 2.5mm 31-808-3246
 Quartz Injector 3.0mm 31-808-3247
 Alumina Injector 1.0mm 31-808-3279
 Alumina Injector 2.0mm 31-808-2835
 Sapphire Injector 2.0mm 31-808-2977



RF Coils

RF Coil for PRO

Silver 70-900-4006S
 Gold 70-900-4006G



RF Coil Installation Kit 70-900-4006T



Common Accessories

Elegra Argon Humidifier

Elegra Argon Humidifier 70-803-1268



Guardian In-Line Filters

Guardian DC in-line non-return gas filter 70-803-1942
 Guardian in-line sample filter 70-803-1108
 Eluo Adaptor for Inline Filter 70-803-1160



Trident Internal Standard Kits

Trident CT Standard Kit 60-703-1179
 Standard Kit for HF 60-808-1150

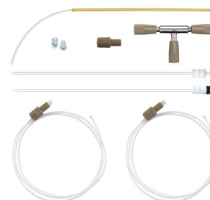

Magnifier Inspection Tool 70-803-1923



Autosampler Probes (See page 20-21 for complete list of probes)**For Cetac ASX-200/500/800 Series**

Guardian Probe 0.75mm
Probe Connecting Line (Red) 70-803-1803

Polyimide sheathed Autosampler
Probe 0.5mm ID 60-808-1186L

PTFE Encapsulated Carbon
Fibre Probe 0.5mm ID 70-803-0784

PTFE Encapsulated Carbon
Fibre Probe 0.75mm ID 70-803-1443

PTFE Encapsulated Carbon
Fibre Probe 1.0mm ID 70-803-0793



Glass DC Nebulizers

SeaSpray

2mL/min uptake	A31-07-USS2
400µL/min uptake	A31-07-USS04

MicroMist

600µL/min uptake	A31-07-UM06
200µL/min uptake	A31-07-UM02
100µL/min uptake	A31-07-UM01
50µL/min uptake	A31-07-UM005



Conikal

2mL/min uptake	A31-07-UC2
1mL/min uptake	A31-07-UC1

Slurry

4mL/min uptake	A31-07-US6
----------------	------------

DC Nebulizers for HF

DuraMist

1mL/min uptake	A31-07-DM1
400µL/min uptake	A31-07-DM04



OpalMist

2mL/min uptake	A31-07-PFA2
600µL/min uptake	A31-07-PFA06
200µL/min uptake	A31-07-PFA02
100µL/min uptake	A31-07-PFA01
50µL/min uptake	A31-07-PFA005



VeeSpray

0.6 - 3mL/min uptake	A31-07-CV6
----------------------	------------



IsoMist XR

Programmable Temperature Cyclonic Spray Chamber

IsoMist XR Kit	KT-1015-XR
----------------	------------

Comprises:

Glass Spray Chamber	21-809-3186
Assembly (ROL)	20-809-5176
PuraFlex Transfer Tube	21-809-3455
UniFit Right Angle Connector (PKT 3)	GAZ-04-90



Spray Chambers

Tracey

50mL Cyclonic	20-809-2665HE
---------------	---------------



Twister

50mL Cyclonic	20-809-2951HE
---------------	---------------



Adaptor

Right Angle With Ball Joint	21-809-2761
Right Angle With Ball Joint (105mm long)	21-809-4237



HydraMist Simultaneous Cold Vapor/ Pneumatic Nebulization Spray Chamber

Thermo Duo 7600 Hydride Kit	KT-1156
Thermo Duo 6000/7200/7400 Hydride Kit	KT-1179



Spray Chambers for HF

Tracey TFE

50mL Cyclonic	20-809-3469
---------------	-------------



Torches

D-Torch 30-808-2844

Comprises:

Base and Inner Tube 31-808-2932
 Quartz Outer Tube 31-808-2840



D-Torch Options:

Ceramic Outer Tube 31-808-3834
 Optic Fibre 170mm 31-808-2933
 Optic Fibre 450mm 31-808-3117
 Retaining Ring 31-808-2707
 Injector Adaptor 31-808-2895
 Injector Ferrule 31-808-2897

PTFE Coated
 Viton O-rings (PKT 10) VT-007
 Viton O-rings (PKT 10) V-026
 O-ring kit for Thermo 6000/7000/PRO D-Torch 70-803-1921
 O-ring and Seal kit for Thermo Torch & Windows 70-803-1550



Ceramic Outer Tube and Optic Fibre for D-Torch

31-808-3079

Comprises:

Ceramic Outer Tube 31-808-3834
 Optic Fibre 170mm 31-808-2933
 Optic Fibre 450mm 31-808-3117



Quartz Torch

EMT Design 31-808-2811



Tapered Injectors for D-Torch & EMT Torch

Quartz Injector 1.0mm 31-808-2833
 Quartz Injector 1.5mm 31-808-2834



Torches

(continued)

Capillary Injectors for D-Torch & EMT Torch

Quartz Injector 2.0mm 31-808-2836
 Quartz Injector 2.5mm 31-808-3246
 Quartz Injector 3.0mm 31-808-3247
 Alumina Injector 1.0mm 31-808-3279
 Alumina Injector 2.0mm 31-808-2835
 Sapphire Injector 2.0mm 31-808-2977



Duo Periscope Window 31-808-2677

O-ring for Periscope Window (PKT 10) 70-803-1603



Quartz Window 70-803-1116



Purged Optical Path (POP) Assembly 70-803-1571

Window & O-Ring for Purged Optical Path (POP) 70-803-1892
 O-ring for Thermo ICP Duo Periscope Window, (PKT 10) 70-803-1603



RF Coils

RF Coil for 6000

Silver, Teflon Coated 70-900-4002S
 Gold, Teflon Coated 70-900-4002G



RF Coil for 7000/6000 Mark II

Silver, Teflon Coated 70-900-4005S
 Gold, Teflon Coated 70-900-4005G



RF Coil Installation Kit 70-900-4002T



Common Accessories

Elegra Argon Humidifier

Elegra Argon Humidifier 70-803-1268



Guardian In-Line Filters

Guardian DC in-line non-return gas filter 70-803-1942

Guardian in-line sample filter 70-803-1108

Eluo Adaptor for Inline Filter 70-803-1160



Trident Internal Standard Kits

Trident CT Standard Kit 60-703-1179

Standard Kit for HF 60-808-1150

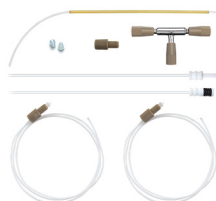

Magnifier Inspection Tool 70-803-1923



Autosampler Probes (See page 20-21 for complete list of probes)

For Cetac ASX-200/500/800 Series

Guardian Probe 0.75mm
Probe Connecting Line (Red) 70-803-1803

Polyimide sheathed Autosampler
Probe 0.5mm ID 60-808-1186L

PTFE Encapsulated Carbon
Fibre Probe 0.5mm ID 70-803-0784

PTFE Encapsulated Carbon
Fibre Probe 0.75mm ID 70-803-1443

PTFE Encapsulated Carbon
Fibre Probe 1.0mm ID 70-803-0793



Glass DC Nebulizers

SeaSpray

2mL/min uptake	A31-07-USS2
400µL/min uptake	A31-07-USS04

MicroMist

600µL/min uptake	A31-07-UM06
200µL/min uptake	A31-07-UM02
100µL/min uptake	A31-07-UM01
50µL/min uptake	A31-07-UM005



Conikal

2mL/min uptake	A31-07-UC2
1mL/min uptake	A31-07-UC1

Slurry

4mL/min uptake	A31-07-US6
----------------	------------

DC Nebulizers for HF

DuraMist

1mL/min uptake	A31-07-DM1
400µL/min uptake	A31-07-DM04



OpalMist

2mL/min uptake	A31-07-PFA2
600µL/min uptake	A31-07-PFA06
200µL/min uptake	A31-07-PFA02
100µL/min uptake	A31-07-PFA01
50µL/min uptake	A31-07-PFA005



VeeSpray

0.6 - 3mL/min uptake	A31-07-CV6
----------------------	------------



IsoMist XR

Programmable Temperature Cyclonic Spray Chamber

IsoMist XR Kit	KT-1021-XR
----------------	------------

Comprises:

Glass Twister Spray Chamber Assembly (LOL)	21-809-3185
PuraFlex Transfer Tube	20-809-5175
Glass Adaptor MB13-32	21-809-3348
Metal Ball Joint Clip	31-808-2790
UniFit Right Angle Connector (PKT 3)	JC-13
	GAZ-04-90



Spray Chambers

Tracey

50mL Cyclonic	20-809-2665HE
---------------	---------------



Twister

50mL Cyclonic	20-809-2951HE
---------------	---------------



Straight Ball Joint Adaptor

21-809-2723



Sheath Gas Adaptor

31-808-3891



Spray Chambers for HF

Tracey TFE

50mL Cyclonic	20-809-9198
---------------	-------------



Torches

D-Torch 30-808-2877

Comprises:

- Base and Inner Tube 31-808-2932
- Quartz Outer Tube 31-808-2878
- Retaining Ring 31-808-2707
- Injector Adaptor 31-808-2895
- Injector Ferrule 31-808-2897



D-Torch Options:

- Ceramic Outer Tube 31-808-3836
- PTFE Coated
- Viton O-rings (PKT 10) VT-007
- Viton O-rings (PKT 10) V-026
- O-ring kit for Thermo 6000/7000/PRO D-Torch 70-803-1921
- O-ring and Seal kit for Thermo Torch & Windows 70-803-1550



Quartz Torch

EMT Design 31-808-2810



Tapered Injectors for D-Torch & EMT Torch

- Quartz Injector 1.0mm 31-808-2833
- Quartz Injector 1.5mm 31-808-2834



Capillary Injectors for D-Torch & EMT Torch

- Quartz Injector 2.0mm 31-808-2836
- Alumina Injector 1.0mm 31-808-3279
- Alumina Injector 2.0mm 31-808-2835
- Sapphire Injector 2.0mm 31-808-2977



RF Coils

RF Coil for 6000 Mark I

- Silver, Teflon Coated 70-900-4002S
- Gold, Teflon Coated 70-900-4002G



RF Coil for 7000/6000 Mark II

- Silver, Teflon Coated 70-900-4005S
- Gold, Teflon Coated 70-900-4005G



RF Coil Installation Kit 70-900-4002T



Common Accessories

Elegra Argon Humidifier

Elegra Argon Humidifier 70-803-1268



Guardian In-Line Filters

- Guardian DC in-line non-return gas filter 70-803-1942
- Guardian in-line sample filter 70-803-1108
- Eluo Adaptor for Inline Filter 70-803-1160



Trident Internal Standard Kits

- Trident CT Standard Kit 60-703-1179
- Standard Kit for HF 60-808-1150

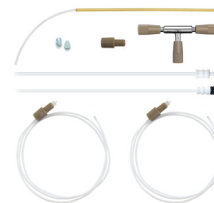

Magnifier Inspection Tool 70-803-1923



Autosampler Probes (See page 20-21 for complete list of probes)

For Cetac ASX-200/500/800 Series

- Guardian Probe 0.75mm
- Probe Connecting Line (Red) 70-803-1803
- Polyimide sheathed Autosampler Probe 0.5mm ID 60-808-1186L
- PTFE Encapsulated Carbon Fibre Probe 0.5mm ID 70-803-0784
- PTFE Encapsulated Carbon Fibre Probe 0.75mm ID 70-803-1443
- PTFE Encapsulated Carbon Fibre Probe 1.0mm ID 70-803-0793



DC Nebulizer Gas Fitting Connectors

Agilent® 4100/4200	70-803-0969
Agilent® Vista/700-ES	70-803-0969
Agilent® 7700/7800/7900/8800/8900	70-803-1105
Agilent® 5100/5110/5800/5900	70-803-1105
Analytik Jena® ICP-MS	70-803-2002
Analytik Jena® ICP-OES	70-803-1105
Horiba® Jobin Yvon (All models)	70-803-1105
Leeman (All models)	70-803-0969
Nu Instruments ICP-MS	70-803-1858
Nu Instruments TOF-ICP-MS	70-803-2044
PerkinElmer® Optima and Avio	70-803-1070
PerkinElmer® Elan/NexION 300/350	70-803-1049
PerkinElmer® NexION 1000, 1100, 2000, 2200, 5000	70-803-1449
Radom MICAP – OES™1000	70-803-2054
Shimadzu® (All models)	70-803-1311
Spectro™ (All models)	70-803-1070
Standard BioTools™ Helios	70-803-1070
Thermo Scientific™ PRO, 6000/7000, Q/RQ/TQ, X-Series & Neoma	70-803-1105
Thermo Scientific™ Neptune	70-803-0969
Elegra to DC Nebulizer	70-803-1278
ICP Gas Inlet Fitting Type 11/61	70-803-1934
ICP Gas Inlet Fitting Type 13/31	70-803-1504
ICP Gas Inlet Fitting Type 21	70-803-1069
ICP Gas Inlet Fitting Type 22	70-803-2110
ICP Gas Inlet Fitting Type 23	70-803-2111
ICP Gas Inlet Fitting Type 41	70-803-1562
ICP Gas Inlet Fitting Type 51	70-803-1857
ICP Gas Inlet Fitting Type 52	70-803-2048
ICP Gas Inlet Fitting Type 70	70-803-2084



DC Nebulizer Gas Fitting

Nexus Universal Nebulizer Connection Kit

The Nexus Universal Nebulizer Connection Kit is a quick and easy way to ensure a leak tight connection of 1/16" or 1.3mm OD sample capillary to a Glass Expansion concentric nebulizer such as the SeaSpray, Conikal, MicroMist, DuraMist or OpalMist nebulizers. If you need to make a leak tight seal to your nebulizer - whether it is to a HPLC for speciation or a high throughput switching valve use this kit.

Nexus Universal Nebulizer Connection Kit (Suitable for DuraMist, OpalMist and glass concentric nebulizers)	FT-16-8-X
Nexus Universal Nebulizer Connection Kit (Suitable for all glass concentric nebulizers)	FT-16-8
Tefzel Ferrule 1/8 inch (PKT 10)	70-803-1513
Tefzel Ferrule 1/16 inch (PKT 10)	70-803-1315

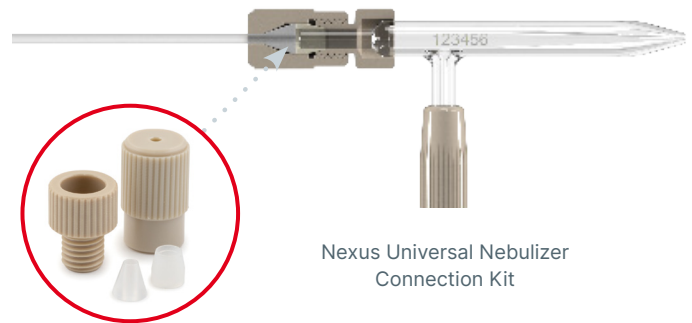

Nexus Universal Nebulizer Connection Kit

EzyLok Kit for Nebulizer Gas Side Arm

EzyLok Kit	EL-1
Comprises:	
EzyLok Connector for 4mm Tubing	QSM-4
EzyLok 6mm Hose Adaptor	70-808-0735
Hose Clip, 6mm	SNP-1

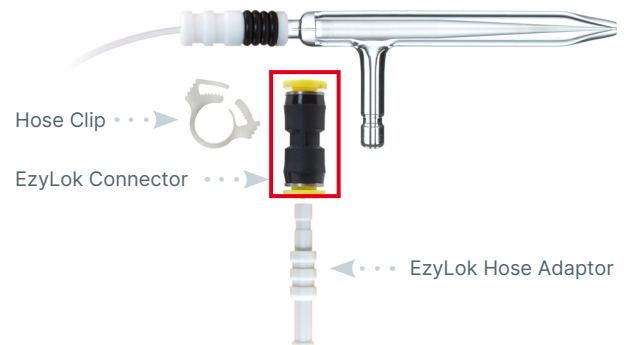

Tubing Connector

1.3mm to 1/16 inch
1/16 inch to 1/16 inch

FT-16-1.3
FT-16-1.6



Tubing Connector 1.3mm to 1/16 inch

Sample Tube Connectors (PKT 10)

	UniFit P/N	EzyFit P/N
0.25mm ID x 1.27mm OD x 700mm long	NFT-025	EZT-025
0.25mm ID x 1.27mm OD x 2000mm long	NFT2-025	EZT2-025
0.50mm ID x 1.27mm OD x 700mm long	NFT-050	EZT-050
0.75mm ID x 1.27mm OD x 700mm long	NFT-075	EZT-075
0.75mm ID x 1.27mm OD x 1500mm long	NFTS-075	EZTS-075
0.25mm ID x 1/16" OD x 700mm long	NFT-16-25	EZT-16-25
0.25mm ID x 1/16" OD x 1500mm long	NFTS-16-25	EZTS-16-25
0.75mm ID x 1/16" OD x 700mm long	NFT-16-75	EZT-16-75
0.75mm ID x 1/16" OD x 1500mm long	NFTS-16-75	EZTS-16-75

Sample Tubing

0.25mm ID x 1.27mm OD x 10m long	STT-025
0.50mm ID x 1.27mm OD x 10m long	STT-050
0.75mm ID x 1.27mm OD x 10m long	STT-075
0.25mm ID x 1/16" OD x 10m long	STT-16-25
0.50mm ID x 1/16" OD x 10m long	STT-16-50
0.75mm ID x 1/16" OD x 10m long	STT-16-75
1.0mm ID x 1/16" OD x 10m long	STT-16-100
0.3mm ID x 0.75mm OD x 10m long	STT-0703
0.13mm ID x 1.27mm OD x 10m long	PFT-013
0.18mm ID x 1.27mm OD x 10m long	PFT-018
0.07mm ID x 1/16" OD x 10m long	PFT-16-07
0.13mm ID x 1/16" OD x 10m long	PFT-16-13
0.18mm ID x 1/16" OD x 10m long	PFT-16-18
1/8" ID x 1/4" OD x 1m long	1/4PFA-HW
Tefzel 0.5mm ID x 1.3mm OD x 10m long	TFE-050



Standard Sample Tubing

Other Tubing

Reagent tube 1.6mm OD x 1.0mm ID x 1400mm long with PTFE Sinkers (PKT. 3)	70-803-0752
Tygon Tubing 1/4 inch x 1m	1921-1M



Reagent tube with PTFE Sinkers



Tygon Tubing



UniFit with sample tube

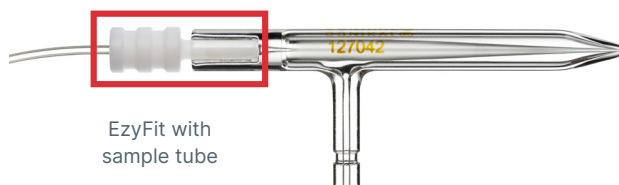

EzyFit with sample tube

Helix & Helix CT Spray Chambers

Helix CT:

Helix CT Locking Screw with Seal	70-803-1439
Helix CT Locking Screw with Seal for MiraMist	70-803-1470
Helix CT Seal (PKT 4)	70-803-1456

Helix:

Helix Locking Screw	70-100-0152
Helix Seal (PKT 4)	70-100-0237

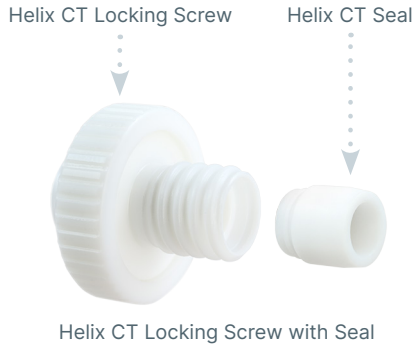

O-Rings Spray Chambers

O-ring set for Large Adaptor (Tracey, Twister)	70-808-0501
O-ring set for Small Adaptor (Cinnabar, Twinnabar)	21-808-0818
Teflon coated Viton O-Rings for spray chamber, nebulizer seal (PKT 10)	VT-009
Teflon coated Viton O-Rings for spray chamber, 16mm large adaptor seal (PKT 10)	VT-10/2
Silicon o-rings for spray chamber, nebulizer seal (PKT 10)	S-009

GazFit Connectors for Torches

GazFit Connectors (PKT 2), for 8mm OD arm	GAZ-08
GazFit Connectors (PKT 4), for 6mm OD torch side arms	GAZ-06
GazFit Connectors (PKT 4), 2 for 6mm OD torch side arms, 2 for 4mm OD torch side arms	GAZ-0604
GazFit Connectors (PKT 4), for 5mm OD torch side arms	GAZ-05
GazFit Connectors (PKT 4), for 4mm OD torch side arms	GAZ-04

GazFit connectors are only suitable for torches with tolerances of no more than +/- 0.15mm on the diameter of the side arms.

All Glass Expansion torches meet this specification.



Clips & Connectors for Spray Chambers

Metal Ball Joint Clip (to connect spray chamber and torch)	JC-13
Metal Ball Joint Clip (to connect spray chamber and torch with S19)	JC-19
Nickel Joint Clip B14 (to connect spray chamber and drain adaptors)	KCM-14
UniFit Connector with sample tube, 0.75mm ID x 1/16" OD x 700mm long (PKT 3)	UFT-16-75
UniFit Connector with sample tube, 0.75mm ID x 1.3mm OD x 700mm long (PKT 3)	UFT-075
UniFit Connector with sample tube, 0.86mm ID x 2mm OD x 480mm long (PKT 3)	UFT-2-86
UniFit Connector with sample tube, 0.86mm ID x 2mm OD x 700mm long (PKT 3)	UFT-2-700
Connector Assembly for Agilent® Scott Spray Chamber	70-803-1476
HydraMist Drain (PKT 4)	GAZ-08-4

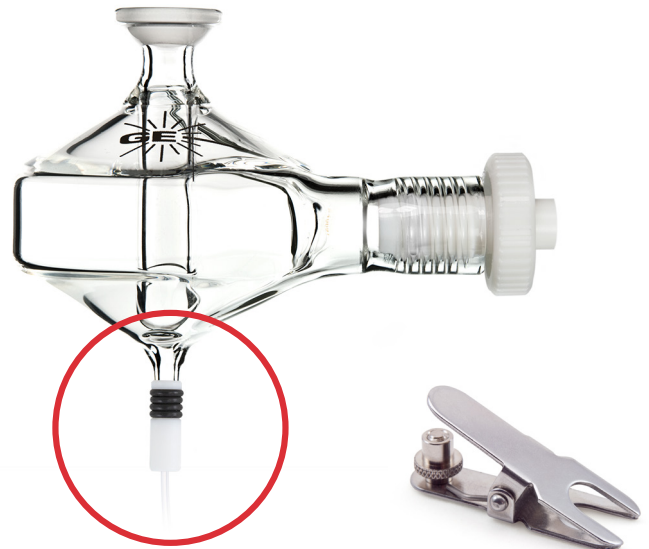

O-Rings for Torches

Viton O-Rings for demountable torch ball joint connectors (PKT 10) 70-V-011



PVC Peristaltic Pump Tubing

All tubes made from Tygon R3603/R3607 or equivalent. Supplied in packs of 12 tubes.

Special Properties:

Inexpensive all-round tubing for general laboratory applications.

Advantages:

- Resistant to almost all inorganic materials.
- Does not age.
- Low gas permeability.
- Smooth inner surface.

Limitations:

- Potential leaching of plasticizers.

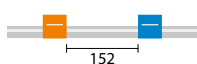

PVC, 2 Bridged, 152mm
(152mm between tags)

Tag Colours	ID (mm)	P/N
orange/black	0.13	0.13-OBLK
orange/red	0.19	0.19-OR
orange/blue	0.25	0.25-OB
orange/green	0.38	0.38-OG
green/yellow	0.44	0.44-GY
orange/yellow	0.51	0.51-OY
white/yellow	0.57	0.57-WY
orange/white	0.64	0.64-OW
black/black	0.76	0.76-BLK
orange/orange	0.89	0.89-ORG
white/black	0.95	0.95-WBLK
white/white	1.02	1.02-WHT
white/red	1.09	1.09-WR
red/red	1.14	1.14-RED
red/grey	1.22	1.22-RGRY
grey/grey	1.30	1.30-GRY
yellow/yellow	1.42	1.42-YLW
yellow/blue	1.52	1.52-YB
blue/blue	1.65	1.65-BLU
blue/green	1.75	1.75-BG
green/green	1.85	1.85-GRN
purple/purple	2.06	2.06-PUR
purple/black	2.29	2.29-PBLK
purple/orange	2.54	2.54-PO
purple/white	2.79	2.79-PW
black/white	3.17	3.17-BLKW

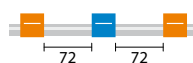

PVC, 3 Bridged, 72mm
(72mm between tags)

Tag Colours	ID (mm)	P/N
orange/black	0.13	0.13-OBLK3B
orange/red	0.19	0.19-OR3B
orange/blue	0.25	0.25-OB3B
orange/green	0.38	0.38-OG3B
green/yellow	0.44	0.44-GY3B
orange/yellow	0.51	0.51-OY3B
white/yellow	0.57	0.57-WY3B
orange/white	0.64	0.64-OW3B
black/black	0.76	0.76-BLK3B
orange/orange	0.89	0.89-ORG3B
white/black	0.95	0.95-WBLK3B
white/white	1.02	1.02-WHT3B
white/red	1.09	1.09-WR3B
red/red	1.14	1.14-RED3B
red/grey	1.22	1.22-RGRY3B
grey/grey	1.30	1.30-GRY3B
yellow/yellow	1.42	1.42-YLW3B
yellow/blue	1.52	1.52-YB3B
blue/blue	1.65	1.65-BLU3B
green/green	1.85	1.85-GRN3B
purple/purple	2.06	2.06-PUR3B
purple/black	2.29	2.29-PBLK3B
purple/orange	2.54	2.54-PO3B
purple/white	2.79	2.79-PW3B
black/white	3.17	3.17-BLKW3B

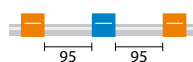

PVC, 3 Bridged, 95mm
(95mm between tags)

Tag Colours	ID (mm)	P/N
orange/blue	0.25	0.25-OB3B-95
orange/green	0.38	0.38-OG3B-95
orange/yellow	0.51	0.51-OY3B-95
orange/white	0.64	0.64-OW3B-95
black/black	0.76	0.76-BLK3B-95
orange/orange	0.89	0.89-ORG3B-95
white/white	1.02	1.02-WHT3B-95
grey/grey	1.30	1.30-GRY3B-95
yellow/blue	1.52	1.52-YB3B-95
green/green	1.85	1.85-GRN3B-95
purple/white	2.79	2.79-PW3B-95

Solva Peristaltic Pump Tubing

All tubes made from Tygon 4040 or equivalent. Supplied in packs of 12 tubes.

Special Properties:

Special tubing for hydrocarbons, petroleum products and distillates.

Advantages:

- Specially formulated to transport hydrocarbons, petroleum products and distillates.
- Ideal for gasoline, kerosene, heating oils, cutting liquids and coolants based on glycols.
- Low gas permeability.

Limitations:

- Not recommended for strong acids and alkalies, foodstuffs, beverages and medicines.
- Potential leaching of plasticizers.

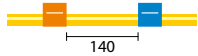

Solva, 2 Bridged, 140mm
(140mm between tags)

Tag Colours	ID (mm)	P/N
orange/blue	0.25	0.25-OB-SF
orange/green	0.38	0.38-OG-SF
orange/yellow	0.51	0.51-OY-SF
orange/white	0.64	0.64-OW-SF
black/black	0.76	0.76-BLK-SF
orange/orange	0.89	0.89-ORG-SF
white/white	1.02	1.02-WHT-SF
red/red	1.14	1.14-RED-SF
grey/grey	1.30	1.30-GRY-SF
yellow/yellow	1.42	1.42-YLW-SF
yellow/blue	1.52	1.52-YB-SF
blue/blue	1.65	1.65-BLU-SF
green/green	1.85	1.85-GRN-SF
purple/purple	2.06	2.06-PUR-SF
purple/black	2.29	2.29-PBLK-SF
purple/orange	2.54	2.54-PO-SF
purple/white	2.79	2.79-PW-SF

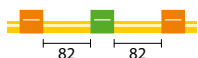

Solva, 3 Bridged, 82mm
(82mm between tags)

Tag Colours	ID (mm)	P/N
orange/green	0.38	0.38-OG3B-SF
black/black	0.76	0.76-BLK3B-SF
orange/orange	0.89	0.89-ORG3B-SF
white/white	1.02	1.02-WHT3B-SF
red/red	1.14	1.14-RED3B-SF
grey/grey	1.30	1.30-GRY3B-SF

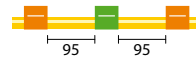

Solva, 3 Bridged, 95mm
(95mm between tags)

Tag Colours	ID (mm)	P/N
orange/green	0.38	0.38-OG3B-95-SF
orange/yellow	0.51	0.51-OY3B-95-SF
black/black	0.76	0.76-BLK3B-95-SF
orange/orange	0.89	0.89-ORG3B-95-SF
white/white	1.02	1.02-WHT3B-95-SF
yellow/blue	1.52	1.52-YB3B-95-SF

Viton® Peristaltic Pump Tubing

All tubes made from Fluran HC F-5500-A or equivalent.

Special Properties:

Special tubing for concentrated acids and corrosive solvents.

Advantages:

- High chemical resistance.
- Low gas permeability.
- Wide temperature range.

Limitations:

- Limited service life.

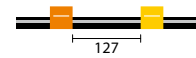

Viton®, 2 Bridged, 127mm
(127mm between tags)

Tag Colours	ID (mm)	P/N
orange/yellow	0.51	VS0.51-OY
orange/white	0.64	VS0.64-OW
black/black	0.76	VS0.76-BLK
orange/orange	0.89	VS0.89-ORG
white/white	1.02	VS1.02-WHT
red/red	1.14	VS1.14-RED
grey/grey	1.30	VS1.30-GRY
yellow/yellow	1.42	VS1.42-YLW
yellow/blue	1.52	VS1.52-YB
blue/blue	1.65	VS1.65-BLU
green/green	1.85	VS1.85-GRN
purple/purple	2.06	VS2.06-PUR
purple/black	2.29	VS2.29-PBLK
purple/orange	2.54	VS2.54-PO
purple/white	2.79	VS2.79-PW

Supplied in packs of 12 tubes

Tygon® MH Peristaltic Pump Tubing

All tubes made from Tygon MHSL 2001.

Special Properties:

- Environmental-friendly tubing especially designed for solvents.
- Suitable for MIBK.

Advantages:







- High chemical resistance.
- Low gas permeability.
- Wide temperature range.

Limitations:

Limited service life.









Tygon® MH , 2 Bridged, 152mm
(152mm between tags)

Tag Colours	ID (mm)	P/N
	0.38	0.38-ORG-MH
	0.64	0.64-OW-MH
	1.02	1.02-WHT-MH
	1.52	1.52-YB-MH
	2.06	2.06-PUR-MH
	2.79	2.79-PW-MH

Supplied in packs of 6 tubes



Tygon® MH , 2 Bridged, 72mm
(72mm between tags)

Tag Colours	ID (mm)	P/N
	0.38	0.38-ORG-MH3
	0.64	0.64-OW-MH3
	1.02	1.02-WHT-MH3
	1.52	1.52-YB-MH3
	2.06	2.06-PUR-MH3
	2.79	2.79-PW-MH3

Supplied in packs of 6 tubes

It can be quite difficult to insert the sample tubing into the peristaltic pump tubes. This is particularly so for pump tubing with a small ID. To facilitate this connection, Glass Expansion supplies Contour flared-end pump tubing. The flared end of this pump tubing allows the larger capillary tubing to be inserted into the smaller pump tubing.

Any of the pump tubing that we normally supply can be supplied with flared end. Simply add “-F” to the end of the part number (eg. 0.38-OG-F). The flared-end tubing is supplied in packs of 6.

Contour Flared-end PVC Peristaltic Pump Tubing

All tubes made from Tygon R3603/R3607 or equivalent. Supplied in packs of 6 tubes.

Special Properties:

Inexpensive all-round tubing for general laboratory applications.

Advantages:







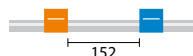











- Transparent.
- Resistant to almost all inorganic materials.
- Does not age.
- Low gas permeability.
- Smooth inner surface.

Limitations:

- Potential leaching of plasticizers.



PVC, 2 Bridged, 152mm
(152mm between tags)

Tag Colours	ID (mm)	P/N
	0.13	0.13-OBLK-F
	0.19	0.19-OR-F
	0.25	0.25-OB-F
	0.38	0.38-OG-F
	0.44	0.44-GY-F
	0.51	0.51-OY-F
	0.57	0.57-WY-F
	0.64	0.64-OW-F
	0.76	0.76-BLK-F
	0.89	0.89-ORG-F
	0.95	0.95-WBLK-F
	1.02	1.02-WHT-F
	1.09	1.09-WR-F
	1.14	1.14-RED-F
	1.22	1.22-RGRY-F
	1.30	1.30-GRY-F
	1.42	1.42-YLW-F
	1.52	1.52-YB-F

Contour Flared-end Peristaltic Pump Tubing

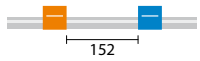

PVC, 2 Bridged, 152mm
(152mm between tags)

(continued)

Tag Colours	ID (mm)	P/N
	1.65	1.65-BLU-F
	1.75	1.75-BG-F
	1.85	1.85-GRN-F
	2.06	2.06-PUR-F
	2.29	2.29-PBLK-F
	2.54	2.54-PO-F
	2.79	2.79-PW-F
	3.17	3.17-BLKW-F

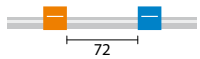

PVC, 2 Bridged, 72mm
(72mm between tags)

Tag Colours	ID (mm)	P/N
	0.19	0.19-OR-F-S
	0.25	0.25-OB-F-S
	0.76	0.76-BLK-F-S
	0.89	0.89-ORG-F-S
	1.02	1.02-WHT-F-S



PVC, 2 Bridged, 95mm
(95mm between tags)

Tag Colours	ID (mm)	P/N
	0.19	0.19-OR-95-F-S
	0.25	0.25-OB-95-F-S
	0.38	0.38-OG-95-F-S
	0.44	0.44-GY-95-F-S
	0.51	0.51-OY-95-F-S
	0.64	0.64-OW-95-F-S
	0.76	0.76-BLK-95-F-S
	1.30	1.30-GRY-95-F-S

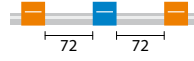

PVC, 3 Bridged, 72mm
(72mm between tags)

Tag Colours	ID (mm)	P/N
	0.13	0.13-OBK3B-F
	0.19	0.19-OR3B-F
	0.25	0.25-OB3B-F
	0.38	0.38-OG3B-F
	0.44	0.44-GY3B-F
	0.51	0.51-OY3B-F
	0.57	0.57-WY3B-F
	0.64	0.64-OW3B-F
	0.76	0.76-BLK3B-F
	0.89	0.89-ORG3B-F
	0.95	0.95-WBLK3B-F
	1.02	1.02-WHT3B-F
	1.09	1.09-WR3B-F
	1.14	1.14-RED3B-F
	1.22	1.22-RGRY3B-F
	1.30	1.30-GRY3B-F
	1.42	1.42-YLW3B-F
	1.52	1.52-YB3B-F
	1.65	1.65-BLU3B-F
	1.85	1.85-GRN3B-F
	2.06	2.06-PUR3B-F
	2.29	2.29-PBLK3B-F
	2.54	2.54-PO3B-F
	2.79	2.79-PW3B-F
	3.17	3.17-BLKW3B-F

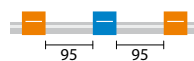

PVC, 3 Bridged, 95mm
(95mm between tags)

Tag Colours	ID (mm)	P/N
	0.25	0.25-OB3B-95-F
	0.38	0.38-OG3B-95-F
	0.51	0.51-OY3B-95-F
	0.76	0.76-BLK3B-95-F
	0.89	0.89-ORG3B-95-F
	1.02	1.02-WHT3B-95-F
	1.30	1.30-GRY3B-95-F
	1.52	1.52-YB3B-95-F
	1.85	1.85-GRN3B-95-F
	2.79	2.79-PW3B-95-F

Contour Flared-end Solva Peristaltic Pump Tubing

All tubes made from Tygon 4040 or equivalent. Supplied in packs of 6 tubes.

Special Properties:

Special tubing for hydrocarbons, petroleum products and distillates.

Advantages:

- Specially formulated to transport hydrocarbons, petroleum products and distillates.
- Ideal for gasoline, kerosene, heating oils, cutting liquids and coolants based on glycols.
- Low gas permeability.

Limitations:

- Not recommended for strong acids and alkalies, foodstuffs, beverages and medicines.
- Potential leaching of plasticizers.

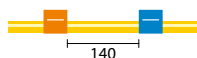

Solva, 2 Bridged, 140mm
(140mm between tags)

Tag Colours	ID (mm)	P/N
orange/blue	0.25	0.25-OB-SF-F
orange/green	0.38	0.38-OG-SF-F
orange/yellow	0.51	0.51-OY-SF-F
orange/white	0.64	0.64-OW-SF-F
black/black	0.76	0.76-BLK-SF-F
orange/orange	0.89	0.89-ORG-SF-F
white/white	1.02	1.02-WHT-SF-F
red/red	1.14	1.14-RED-SF-F
grey/grey	1.30	1.30-GRY-SF-F
yellow/yellow	1.42	1.42-YLW-SF-F
yellow/blue	1.52	1.52-YB-SF-F
blue/blue	1.65	1.65-BLU-SF-F
green/green	1.85	1.85-GRN-SF-F
purple/purple	2.06	2.06-PUR-SF-F
purple/black	2.29	2.29-PBLK-SF-F
purple/orange	2.54	2.54-PO-SF-F
purple/white	2.79	2.79-PW-SF-F

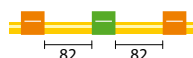

Solva, 3 Bridged, 82mm
(82mm between tags)

Tag Colours	ID (mm)	P/N
orange/green	0.38	0.38-OG3B-SF-F
black/black	0.76	0.76-BLK3B-SF-F
orange/orange	0.89	0.89-ORG3B-SF-F
red/red	1.14	1.14-RED3B-SF-F
grey/grey	1.30	1.30-GRY3B-SF-F

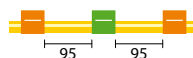

Solva, 3 Bridged, 95mm
(95mm between tags)

Tag Colours	ID (mm)	P/N
orange/green	0.38	0.38-OG3B-95-SF-F
orange/yellow	0.51	0.51-OY3B-95-SF-F
black/black	0.76	0.76-BLK3B-95-SF-F
orange/orange	0.89	0.89-ORG3B-95-SF-F
white/white	1.02	1.02-WHT3B-95-SF-F
yellow/blue	1.52	1.52-YB3B-95-SF-F

Contour Flared-end Viton® Peristaltic Pump Tubing

All tubes made from Fluran HC F-5500-A or equivalent.

Special Properties:

Special tubing for concentrated acids and corrosive solvents.

Advantages:

- High chemical resistance.
- Low gas permeability.
- Wide temperature range.

Limitations:

Limited service life.

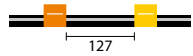

Viton®, 2 Bridged, 127mm
(127mm between tags)

Tag Colours	ID (mm)	P/N
	0.51	VS0.51-OY-F
	0.64	VS0.64-OW-F
	0.76	VS0.76-BLK-F
	0.89	VS0.89-ORG-F
	1.02	VS1.02-WHT-F
	1.14	VS1.14-RED-F
	1.30	VS1.30-GRY-F
	1.42	VS1.42-YLW-F
	1.52	VS1.52-YB-F
	1.65	VS1.65-BLU-F
	1.85	VS1.85-GRN-F
	2.06	VS2.06-PUR-F
	2.29	VS2.29-PBLK-F
	2.54	VS2.54-PO-F
	2.79	VS2.79-PW-F

Supplied in packs of 6 tubes

Contour Flared-end Tygon® MH Peristaltic Pump Tubing

All tubes made from Tygon MHSL 2001.

Special Properties

- Environmental-friendly tubing especially designed for solvents.
- Suitable for MIBK.

Advantages:

- High chemical resistance.
- Low gas permeability.
- Wide temperature range.

Limitations:

Limited service life.

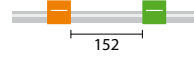

Tygon® MH, 2 Bridged, 152mm
(152mm between tags)

Tag Colours	ID (mm)	P/N
	0.38	0.38-ORG-MH-F
	0.64	0.64-OW-MH-F
	1.02	1.02-WHT-MH-F
	1.52	1.52-YB-MH-F
	2.06	2.06-PUR-MH-F
	2.79	2.79-PW-MH-F

Supplied in packs of 6 tubes

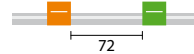

Tygon® MH, 2 Bridged, 72mm
(72mm between tags)

Tag Colours	ID (mm)	P/N
	0.38	0.38-ORG-MH3-F
	0.64	0.64-OW-MH3-F
	1.02	1.02-WHT-MH3-F
	1.52	1.52-YB-MH3-F
	2.06	2.06-PUR-MH3-F
	2.79	2.79-PW-MH3-F

Supplied in packs of 6 tubes



Asia Pacific

6 Central Boulevard
Port Melbourne
Vic 3207, Australia

Telephone: +61 3 9320 1111

Email: enquiries@geicp.com

Europe

Friedenbachstrasse 9
35781 Weilburg
Germany

Telephone: +49 6471 3778517

Email: gegmbh@geicp.com

Americas

31 Jonathan Bourne Drive, Unit 7
Pocasset, MA 02559, USA

Toll Free Phone: 800 208 0097

Telephone: 508 563 1800

Facsimile: 508 563 1802

Email: geusa@geicp.com

April 2025